



Bio-Pharm Fittings

ASME BPE



Semiconductor



Bio-Pharm



Hygienic



NEUMO Ehrenberg Group

MaxPure – Maximum Purity With Guaranteed Ra

Where cleanability of fittings is the issue, every step in the production process must be carefully controlled. Our production methods insure that no mechanical damage or flaws occur during manufacturing. The cleaning procedures incorporate multi-process degreasing and washing steps provided to eliminate any residues of hydrocarbons and stains, using pure deionized water. Our procedures and process capabilities result in the formation of a stabilized passive layer and increased corrosion resistance.

Our products proudly offer:

Maximum Cleanability

MaxPure fittings are cleaned using a multiple step process to assure clean surface, areas inside and out with repeatability every time. Every fitting is passivated according to ASME BPE and ASTM A967 standards.

Full Traceability

We provide full traceability for each of our products by supplying all necessary production process data. Starting from certifications and incoming inspection of raw materials, through in-process quality control, final inspection, marking and packaging. The process is also completely documented with a unique job number for each BPE process component.

Every Fitting is Quality Inspected

All around quality and meticulous inspection insures that every fitting will be of the highest quality and in total compliance with all ASME-BPE standards. MaxPure fittings are 100% visual inspected.

NEUMO Ehrenberg Group

The NEUMO Ehrenberg Group, a diversified multi-national organization headquartered in Germany, was founded by Senator Henry Ehrenberg in 1947. Over the last decade, the Group has become a leading manufacturer for worldwide Biopharmaceutical process fittings and components. With its three leading companies, NEUMO, VNE and EGMO, the group has developed a worldwide distribution network supporting major Biopharmaceutical multinational accounts.

The Neumo Ehrenberg Group's synergy and strategy toward the Biopharmaceutical sectors provide customers with innovation, all around quality and efficiency. Through our Group's volunteer participation in leading standards organizations, we are actively involved in shaping the future for a cleaner, safer and more productive workplace in the Biopharmaceutical Processing Industry.



Index

Fittings Specifications.....	Page 4
Electro-Polishing.....	Page 6
Tube Specifications.....	Page 8
Ordering Information.....	Page 8
Fittings.....	Page 9



Elbows | Page 9-12 |



Tees | Page 13-21 |



Reducers | Page 22-27 |



Use Points | Page 28 |



True Y's & Laterals | Page 29-30 |



Crosses | Page 31-32 |



Ferrules | Page 33 |



Solid End Caps & Weld Caps
| Page 34 |

Accessories.....	Page 35
------------------	---------



Gaskets | Page 35 |



Clamps | Page 36-37 |



Adapters | Page 38-39 |



Stub Ends & Slip On Flanges
| Page 39 |

ASME BPE DT Index.....	Page 40
Bio Fittings.....	Page 44
Manifolds (Multi Tee).....	Page 46
Customized Components.....	Page 47
MTR - Material Test Report.....	Page 48
Technical Information.....	Page 49
Industry Terms Glossary.....	Page 51
ASME BPE - Certificate.....	Page 55

MaxPure – Fittings Specifications

Product:

Stainless Steel fittings comply with ASME BPE standards.
Gaskets are made from compounds which are FDA approved and USP 87, 88 Pharmaceutical Class VI certified.

Sizes:

Stainless Steel fittings are available in sizes 1/4" - 6" O.D. tube size.

Material:

Fittings are fabricated in AISI 316L Stainless Steel with sulfur content of 0.005-0.017% achieving superior repeatability for automatic orbital welding process.

Dimensions & Tolerances:

Dimensions as specified in ASME BPE Part DT-3-1

Nominal Size	O.D.		Wall Thickness Mechanical Polish (MP)		Wall Thickness Electropolish (EP)		Squareness Face to Tangent, B		Off Angle, 0		Equivalent Angle (for O)	Off Plane, P		Centerline Radius (CLR), R	
	in.	in. mm	in.	mm	in.	mm	in.	mm	in.	mm	deg	in.	mm	in.	mm
1/4	±0.005	±0.13	+0.003/-0.004	+0.08/-0.10	+0.003/-0.006	+0.08/-0.15	0.005	0.13	0.009	0.23	2.1	0.030	0.76	0.563	14.30
3/8	±0.005	±0.13	+0.003/-0.004	+0.08/-0.10	+0.003/-0.006	+0.08/-0.15	0.005	0.13	0.012	0.3	1.8	0.030	0.76	1.125	28.58
1/2	±0.005	±0.13	+0.005/-0.008	+0.13/-0.20	+0.005/-0.010	+0.13/-0.25	0.005	0.13	0.014	0.36	1.6	0.030	0.76	1.125	28.58
3/4	±0.005	±0.13	+0.005/-0.008	+0.13/-0.20	+0.005/-0.010	+0.13/-0.25	0.005	0.13	0.018	0.46	1.4	0.030	0.76	1.125	28.58
1	±0.005	±0.13	+0.005/-0.008	+0.13/-0.20	+0.005/-0.010	+0.13/-0.25	0.008	0.20	0.025	0.64	1.4	0.030	0.76	1.500	38.10
1 1/2	±0.008	±0.20	+0.005/-0.008	+0.13/-0.20	+0.005/-0.010	+0.13/-0.25	0.008	0.20	0.034	0.86	1.3	0.050	1.27	2.250	57.15
2	±0.008	±0.20	+0.005/-0.008	+0.13/-0.20	+0.005/-0.010	+0.13/-0.25	0.008	0.20	0.043	1.09	1.2	0.050	1.27	3.000	76.20
2 1/2	±0.010	±0.25	+0.005/-0.008	+0.13/-0.20	+0.005/-0.010	+0.13/-0.25	0.010	0.25	0.054	1.37	1.2	0.050	1.27	3.750	95.25
3	±0.010	±0.25	+0.005/-0.008	+0.13/-0.20	+0.005/-0.010	+0.13/-0.25	0.016	0.41	0.068	1.73	1.3	0.050	1.27	4.500	114.30
4	±0.015	±0.38	+0.008/-0.010	+0.20/-0.25	+0.008/-0.012	+0.20/-0.30	0.016	0.41	0.086	2.18	1.2	0.060	1.52	6.000	152.40
6	±0.030	±0.76	+0.015/-0.015	+0.38/-0.38	+0.015/-0.017	+0.38/-0.43	0.030	0.76	0.135	3.43	1.3	0.060	1.52	9.000	228.60

Roundness

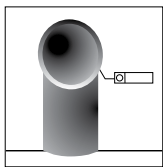

Wall Thickness

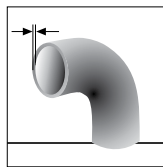

Squareness Face to Tangent

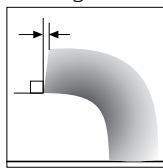

Off Angle

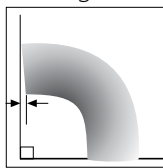

Off Plane

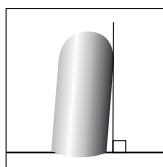

Height

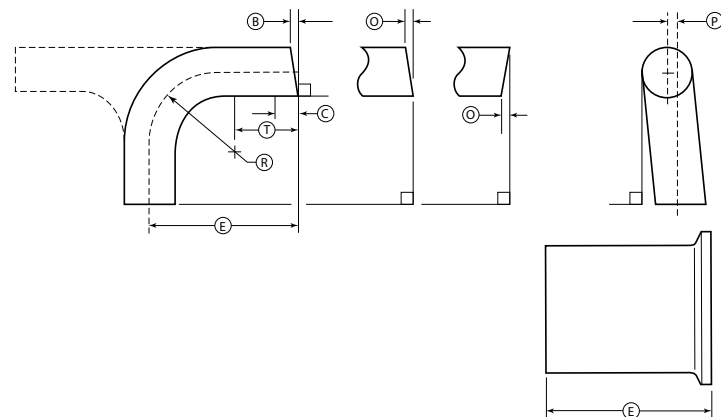
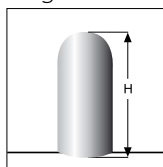

General Notes:

- a. Tolerance on (E) end-to-end and center-to-end: 0.050 in. (1.27 mm)
- b. Tolerance for centerline radius (CLR) is ±10% of the nominal dimension

Fittings Specifications

Surface Finish:

Reference: ASME BPE-2014, Part SF, Table SF-2.4-1.

Surface Finish Code	BPE Surface Designation	Ra Maximum		Inside Surface	Outside Surface
		μ-in.	μm	Surface Condition	Surface Condition
PX	SF0			No finish requirement	No finish requirement
PC	SF1	20	0.51	Mechanically Polished [1]	Light Polish
PL	SF1	20	0.51	Mechanically Polished [1]	Mechanically polished to 32 Ra μ-in.
PD	SF4	15	0.38	Mechanically Polished [1] & Electropolished	Light Polish
PM	SF4	15	0.38	Mechanically Polished [1] & Electropolished	Mechanically polished to 32 Ra μ-in.
PR	-	10	0.25	Mechanically Polished [1] & Electropolished	Mechanically polished to 32 Ra μ-in.

[1] Or any other finishing method that meets the Ra max.

- MaxPure fittings guarantee the Ra in all internal surfaces, including bent areas where it is difficult to polish and difficult to measure.
- All Ra readings are taken across the lay, wherever possible.
- No single Ra reading shall exceed the Ra max. value in this table.
- Other Ra readings are available if agreed upon between owner/user and supplier, not to exceed values in this table.

Cleaning:

A multi step cleaning cycle is conducted to ensure that fittings are cleaned with a perfect passivation layer. The cleaning process involves degreasing, pickling, electro polishing (as required) and passivation. During the final stage, the fittings are double-rinsed using D.I. water.

Inspection Procedures:

All fittings produced by EGMO production are 100% visually inspected for any surface finish imperfections, as mentioned in Table SF-2.2-1, SF-2.2-2, SF-2.4-1 and SF 2.6-1 in the ASME BPE 2014 specification. All dimensional characteristics are inspected for tolerances listed in parts DT-3-1 to DT-9.3-1 in the ASME BPE 2014 specification.

Fitting Marking Information:

Each fitting and process component is permanently laser Marked to show the following:

- Heat number/code traceable to material test report for each product contact surface component
- Material type
- Manufacturer's name, logo, & trademark
- Product contact surface designation for the appropriate BPE specification
- ASME BPE mark 



Packaging & Labeling:

Each fitting is capped, bagged and labeled in full compliance with the ASME BPE standard. Every label includes a QR Code which directs to the fitting's Material Test Report (Please refer to page 46).

Documentation:

Full Material Test Reports are supplied with the finished products and are available On-Line at www.MaxPure.net

MaxPure - Electro-Polishing

Why MaxPure EP Bio-Pharm Fittings Lead the Industry

MaxPure EP is EGMO's line of stainless steel fittings that meet - and exceed - the highly specialized surface finishing requirements of the bio-pharma industry as detailed in the ASME BPE (The American Society of Mechanical Engineers - Bioprocessing Equipment) guidelines.

The uncompromising high quality of EGMO's **MaxPure EP** products is a result of years of experience and accumulated know-how in the electropolishing process during which EGMO has optimized the following four critical elements:

- a. The temperature of the electrolyte solution.
- b. The amplitude of the cathodes and their location relevant to the product.
- c. The level of acidity of the solution.
- d. The amount of the time that the part is immersed in the solution.

NOTE: The ASME BPE guidelines are very clear, for example, that flash electropolishing, i.e., immersion of the part in the electrolyte solution for a very short period of time, is unacceptable.

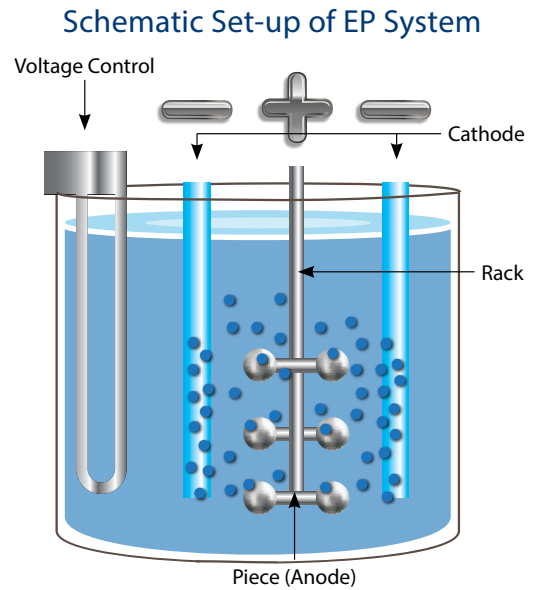

As a result, **MaxPure EP** products stand out from competing products in the following ways:

- A thicker EP layer to minimize rouging
- Higher Chrome concentration for better corrosion resistance
- Guaranteed smoothness (Ra) in all internal surfaces to reduce Bio film

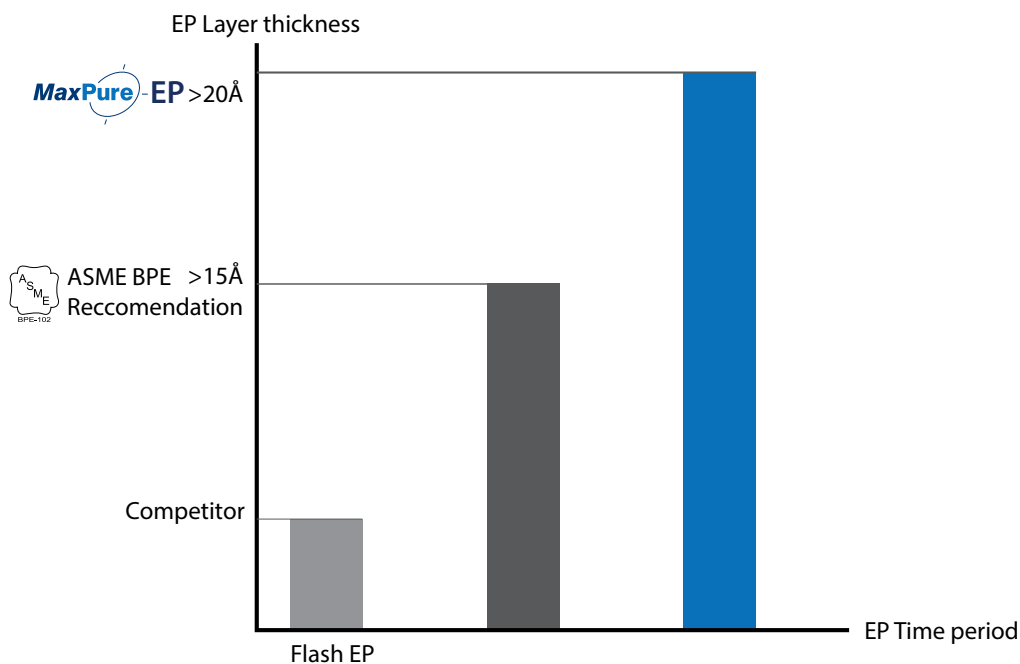

Removal of Contaminants

MaxPure EP removes the contaminants that were introduced by the various production processes. The unique **MaxPure EP** process achieves a level of contaminant removal that exceeds the ASME BPE standard.

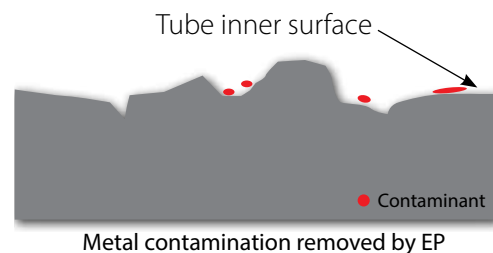

Superior Corrosion Resistance

During the electropolishing process naturally occurring chrome in the product's base metal is "pulled" to the surface. The thicker the chrome layer that forms on the product surface, the more resistant it will be to corrosion over time. It will also decrease rouging.

The highly optimized **MaxPure EP** process ensures a particularly thick chrome layer - one of the reasons why **MaxPure EP** fittings dominate the bio-pharma sector.

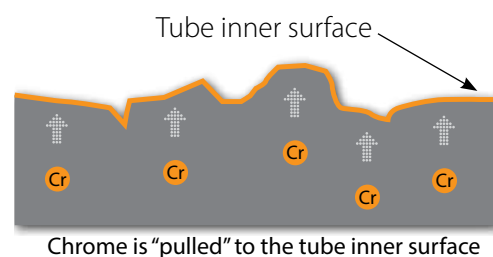

Unparalleled Surface Smoothness

The holy grail of surface finishing smoothness is to achieve as low an Ra (Roughness average) value as possible, where Ra is the arithmetic mean of the vertical deviations of the roughness profile from a mean line.

Rougher surfaces create more friction and wear quicker. Surface irregularities are potential sites not only for the formation of cracks and corrosion, but for the build-up of bacteria. Mechanical polishing and buffing, which is the first stage of surface finishing for metals, can achieve good Ra values, but inevitably leave microscopic metal particles and other contaminants on the top surface layer, as well as compounds and foreign matter trapped just below the surface layer.



Before MaxPure EP

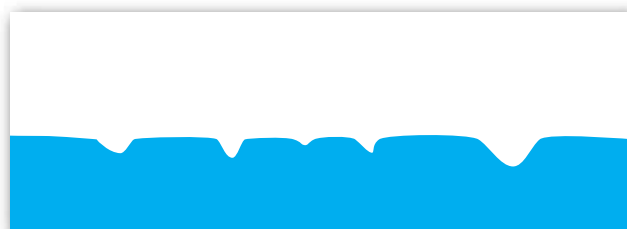

After MaxPure EP

The **MaxPure EP** process dramatically improves the mechanically polished surface smoothness.

MaxPure EP Exceeds the ASME BPE Quality Requirements

The table below shows how **MaxPure EP** exceeds the ASME BPE quality requirements.

- ✓ The thickness of the electropolish layer, measured in Angstroms.
The thicker the layer, the more contaminant-free and corrosion-resistant the fitting is.
- ✓ Cr/Fe: The ratio of chrome/iron.
The higher the ratio, the higher the corrosion-resistance.

Attribute	ASME BPE Recommendation	EGMO Electropolishing
EP layer thickness	15Å° <	20Å° <
CR/Fe ratio	1 <	1.5 <

Tube Specifications

Standards:

- ASTM A-269 / A270-S2
- ASME BPE

Surface Finish:

Surface finish specifications are the same for fittings & tubes. Please refer to table SF-2.4-1 page 5.

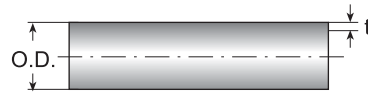

Tubing Dimensional Tolerances: Tubing specifications, ASTM A-269/A270-S2

Tubing Diameter		Wall Thickness		OD Tolerance Length (ASTM Spec.)		Length (ASTM Spec.)		Wall Thickness Tolerance
inch	mm.	inch	mm.	inch	mm.	inch	mm.	ASTM Spec.
1/4"	6.35	0.035	0.89	+/- 0.005	+/- 0.127	0.125	3.175	+/- 10%
3/8"	9.53	0.035	0.89	+/- 0.005	+/- 0.128	0.125	3.175	+/- 10%
1/2"	12.70	0.065	1.65	+/- 0.005	+/- 0.129	0.125	3.175	+/- 10%
3/4"	19.05	0.065	1.65	+/- 0.005	+/- 0.130	0.125	3.175	+/- 10%
1"	25.40	0.065	1.65	+/- 0.005	+/- 0.131	0.125	3.175	+/- 10%
1 1/2"	38.10	0.065	1.65	+/- 0.008	+/- 0.203	0.125	3.175	+/- 10%
2"	50.80	0.065	1.65	+/- 0.008	+/- 0.204	0.125	3.175	+/- 10%
2 1/2"	63.50	0.065	1.65	+/- 0.010	+/- 0.254	0.125	3.175	+/- 10%
3"	76.20	0.065	1.65	+/- 0.015	+/- 0.381	0.125	3.175	+/- 10%
4"	101.60	0.083	2.11	+/- 0.015	+/- 0.381	0.188	4.763	+/- 10%
6"	152.40	0.109	2.77	+/- 0.030	+/- 0.762	0.188	4.763	+/- 10%

Ordering Information

To specify the part completely, start with the product description and select the additional options as shown below:

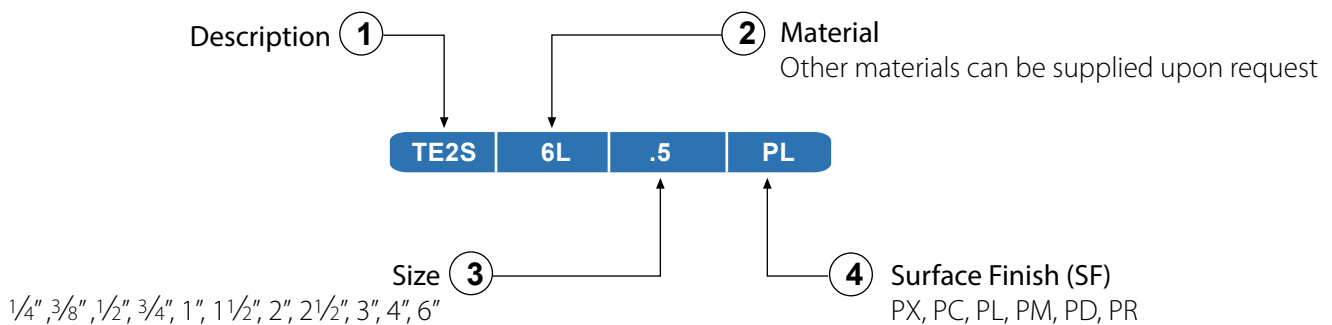

90° weld ends elbow, 1/2" size, PL surface finish.

Elbows - 45°

TE2KS - 45° ELBOW

Nominal Size in.	Dimensions		Ordering Code
	A in.	A mm	
1/4	2.000	50.8	TE2KS6L.25-..
3/8	2.000	50.8	TE2KS6L.375-..
1/2	2.250	57.2	TE2KS6L.5-..
3/4	2.250	57.2	TE2KS6L.75-..
1	2.250	57.2	TE2KS6L1.0-..
1 1/2	2.500	63.5	TE2KS6L1.5-..
2	3.000	76.2	TE2KS6L2.0-..
2 1/2	3.375	85.7	TE2KS6L2.5-..
3	3.625	92.1	TE2KS6L3.0-..
4	4.500	114.3	TE2KS6L4.0-..
6	6.250	158.8	TE2KS6L6.0-..

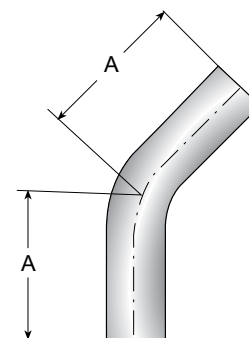

BPE TABLE # DT-4.1.1-4

TE2KC - 45° ELBOW CLAMP ONE END

Nominal Size in.	Dimensions				Ordering Code
	A in.	A mm	B in.	B mm	
1/4	2.000	50.8	1.000	25.4	TE2KC6L.25-..
3/8	2.000	50.8	1.000	25.4	TE2KC6L.375-..
1/2	2.250	57.2	1.000	25.4	TE2KC6L.5-..
3/4	2.250	57.2	1.000	25.4	TE2KC6L.75-..
*1	2.250	57.2	1.125	28.6	TE2KC6L1.0-..
1 1/2	2.500	63.5	1.438	36.5	TE2KC6L1.5-..
2	3.000	76.2	1.750	44.5	TE2KC6L2.0-..
2 1/2	3.375	85.7	2.063	52.4	TE2KC6L2.5-..
3	3.625	92.1	2.375	60.3	TE2KC6L3.0-..
4	4.500	114.3	3.125	79.4	TE2KC6L4.0-..
6	6.250	158.8	5.250	133.4	TE2KC6L6.0-..

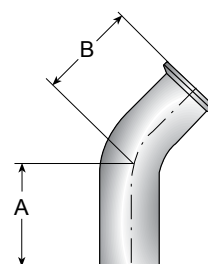

BPE TABLE # DT-4.1.1-5

* **Note:** 1" Clamp Ferrule can also be orderd with "Type A" connections according to the ASME BPE standard.

TEG2K - 45° ELBOW

Nominal Size in.	Dimensions		Ordering Code
	A in.	A mm	
1/4	1.000	25.4	TEG2K6L.25-..
3/8	1.000	25.4	TEG2K6L.375-..
1/2	1.000	25.4	TEG2K6L.5-..
3/4	1.000	25.4	TEG2K6L.75-..
*1	1.125	28.6	TEG2K6L1.0-..
1 1/2	1.438	36.5	TEG2K6L1.5-..
2	1.750	44.5	TEG2K6L2.0-..
2 1/2	2.063	52.4	TEG2K6L2.5-..
3	2.375	60.3	TEG2K6L3.0-..
4	3.125	79.4	TEG2K6L4.0-..
6	5.250	133.4	TEG2K6L6.0-..

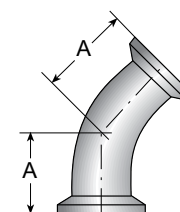

BPE TABLE # DT-4.1.1-6

* **Note:** 1" Clamp Ferrule can also be orderd with "Type A" connections according to the ASME BPE standard.

Elbows - 88°

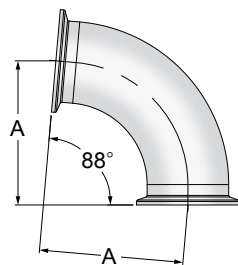
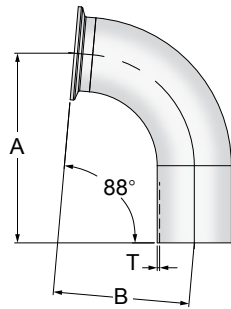
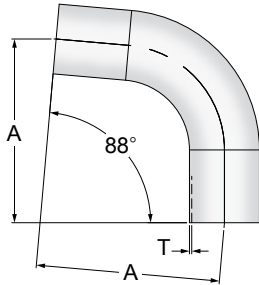

TE2S - 88° ELBOW

Nominal Size in.	Dimensions				Ordering Code
	T		α=88°		
	in.	mm	A in.	A mm	
1/2	0.65	1.65	3.06	77.7	TE2S886L.5-..
3/4	0.65	1.65	3.06	77.7	TE2S886L.75-..
1	0.65	1.65	3.05	77.5	TE2S886L1.0-..
1 1/2	0.65	1.65	3.80	96.5	TE2S886L1.5-..
2	0.65	1.65	4.81	122.2	TE2S886L2.0-..
2 1/2	0.65	1.65	5.56	141.2	TE2S886L2.5-..
3	0.65	1.65	6.31	160.3	TE2S886L3.0-..
4	0.83	2.11	8.07	205.0	TE2S886L4.0-..

TE2C - 88° ELBOW

Nominal Size in.	Dimensions						Ordering Code
	T			α=88°			
	in.	mm	A in.	A mm	B in.	B mm	
1/2	0.65	1.65	3.01	76.50	1.71	43.50	TE2C886L.5-..
3/4	0.65	1.65	3.01	76.50	1.71	43.50	TE2C886L.75-..
*1	0.65	1.65	3.01	76.50	2.04	51.80	TE2C886L1.0-..
1 1/2	0.65	1.65	3.76	95.60	2.79	70.75	TE2C886L1.5-..
2	0.65	1.65	4.73	120.10	3.62	92.00	TE2C886L2.0-..
2 1/2	0.65	1.65	5.51	140.00	4.22	107.25	TE2C886L2.5-..
3	0.65	1.65	6.27	159.20	4.94	125.40	TE2C886L3.0-..
4	0.83	2.11	8.02	203.75	6.42	163.10	TE2C886L4.0-..

Note: 89° & 91° elbows are available upon request.
** Note: 1" Clamp Ferrule can also be orderd with "Type A" connections according to the ASME BPE standard.*

TEG2C - 88° ELBOW

Nominal Size in.	Dimensions				Ordering Code
	T		α=88°		
	in.	mm	A in.	A mm	
1/2	0.65	1.65	1.63	41.3	TEG2C886L.5-..
3/4	0.65	1.65	1.63	41.3	TEG2C886L.75-..
*1	0.65	1.65	2.01	51.1	TEG2C886L1.0-..
1 1/2	0.65	1.65	2.76	70.2	TEG2C886L1.5-..
2	0.65	1.65	3.51	89.2	TEG2C886L2.0-..
2 1/2	0.65	1.65	4.26	108.3	TEG2C886L2.5-..
3	0.65	1.65	5.01	127.3	TEG2C886L3.0-..
4	0.83	2.11	6.65	168.8	TEG2C886L4.0-..

** Note: 1" Clamp Ferrule can also be orderd with "Type A" connections according to the ASME BPE standard.*

Elbows - 90°

TE2S - 90° ELBOW

Nominal Size in.	Dimensions		Ordering Code
	A in.	A mm	
1/4	2.625	66.7	TE2S6L.25-..
3/8	2.625	66.7	TE2S6L.375-..
1/2	3.000	76.2	TE2S6L.5-..
3/4	3.000	76.2	TE2S6L.75-..
1	3.000	76.2	TE2S6L1.0-..
1 1/2	3.750	95.3	TE2S6L1.5-..
2	4.750	120.7	TE2S6L2.0-..
2 1/2	5.500	139.7	TE2S6L2.5-..
3	6.250	158.8	TE2S6L3.0-..
4	8.000	203.2	TE2S6L4.0-..
6	11.500	292.1	TE2S6L6.0-..

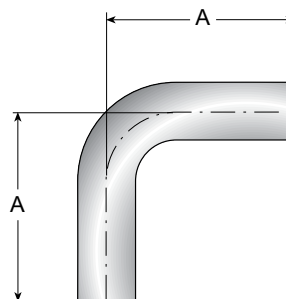

BPE TABLE # DT-4.1.1-1

TE2C - 90° ELBOW CLAMP ONE END

Nominal Size in.	Dimensions				Ordering Code
	A in.	A mm	B in.	B mm	
1/4	2.625	66.7	1.625	41.3	TE2C6L.25-..
3/8	2.625	66.7	1.625	41.3	TE2C6L.375-..
1/2	3.000	76.2	1.625	41.3	TE2C6L.5-..
3/4	3.000	76.2	1.625	41.3	TE2C6L.75-..
*1	3.000	76.2	2.000	50.8	TE2C6L1.0-..
1 1/2	3.750	95.3	2.750	69.9	TE2C6L1.5-..
2	4.750	120.7	3.500	88.9	TE2C6L2.0-..
2 1/2	5.500	139.7	4.250	108.0	TE2C6L2.5-..
3	6.250	158.8	5.000	127.0	TE2C6L3.0-..
4	8.000	203.2	6.625	168.3	TE2C6L4.0-..
6	11.500	292.1	10.500	266.7	TE2C6L6.0-..

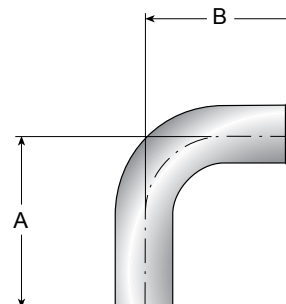

BPE TABLE # DT-4.1.1-2

* Note: 1" Clamp Ferrule can also be orderd with "Type A" connections according to the ASME BPE standard.

TEG2C - 90° ELBOW

Nominal Size in.	Dimensions		Ordering Code
	A in.	A mm	
1/4	1.625	41.3	TEG2C6L.25-..
3/8	1.625	41.3	TEG2C6L.375-..
1/2	1.625	41.3	TEG2C6L.5-..
3/4	1.625	41.3	TEG2C6L.75-..
*1	2.000	50.8	TEG2C6L1.0-..
1 1/2	2.750	69.9	TEG2C6L1.5-..
2	3.500	88.9	TEG2C6L2.0-..
2 1/2	4.250	108.0	TEG2C6L2.5-..
3	5.000	127.0	TEG2C6L3.0-..
4	6.625	168.3	TEG2C6L4.0-..
6	10.500	266.7	TEG2C6L6.0-..

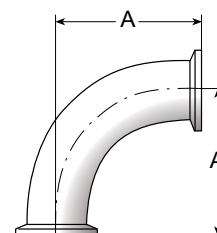

BPE TABLE # DT-4.1.1-3

* Note: 1" Clamp Ferrule can also be orderd with "Type A" connections according to the ASME BPE standard.

Elbows - 92°

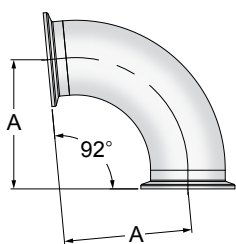
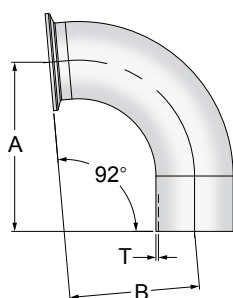
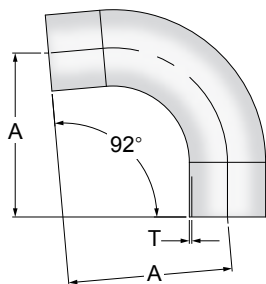

TE2S - 92° ELBOW

Nominal Size in.	Dimensions				Ordering Code
	T		$\alpha=92^\circ$		
	in.	mm	A in.	A mm	
1/2	0.65	1.65	2.93	74.4	TE2S926L.5-..
3/4	0.65	1.65	2.93	74.4	TE2S926L.75-..
1	0.65	1.65	2.95	74.9	TE2S926L1.0-..
1 1/2	0.65	1.65	3.69	93.7	TE2S926L1.5-..
2	0.65	1.65	4.69	119.1	TE2S926L2.0-..
2 1/2	0.65	1.65	5.44	138.2	TE2S926L2.5-..
3	0.65	1.65	6.19	157.2	TE2S926L3.0-..
4	0.83	2.115	7.93	201.4	TE2S926L4.0-..

TE2C - 92° ELBOW

Nominal Size in.	Dimensions						Ordering Code
	T			$\alpha=92^\circ$			
	in.	mm	A in.	A mm	B in.	B mm	
1/2	0.65	1.65	2.98	75.7	1.66	42.1	TE2C926L.5-..
3/4	0.65	1.65	2.98	75.7	1.66	42.1	TE2C926L.75-..
*1	0.65	1.65	2.98	75.7	2.05	52.1	TE2C926L1.0-..
1 1/2	0.65	1.65	3.73	94.8	2.73	69.3	TE2C926L1.5-..
2	0.65	1.65	4.77	121.2	3.47	88.2	TE2C926L2.0-..
2 1/2	0.65	1.65	5.43	137.8	4.10	104.2	TE2C926L2.5-..
3	0.65	1.65	6.17	156.8	4.83	122.8	TE2C926L3.0-..
4	0.83	2.115	7.91	200.8	6.42	163.0	TE2C926L4.0-..

Note: 89° & 91° elbows are available upon request.

* Note: 1" Clamp Ferrule can also be orderd with "Type A" connections according to the ASME BPE standard.

TEG2C - 92° ELBOW

Nominal Size in.	Dimensions				Ordering Code
	T		$\alpha=92^\circ$		
	in.	mm	A in.	A mm	
1/2	0.65	1.65	1.61	40.8	TEG2C926L.5-..
3/4	0.65	1.65	1.61	40.8	TEG2C926L.75-..
*1	0.65	1.65	1.99	50.5	TEG2C926L1.0-..
1 1/2	0.65	1.65	2.74	69.6	TEG2C926L1.5-..
2	0.65	1.65	3.49	88.6	TEG2C926L2.0-..
2 1/2	0.65	1.65	4.04	102.6	TEG2C926L2.5-..
3	0.65	1.65	4.76	120.8	TEG2C926L3.0-..
4	0.83	2.115	6.30	160.0	TEG2C926L4.0-..

* Note: 1" Clamp Ferrule can also be orderd with "Type A" connections according to the ASME BPE standard.

Tees - Equal

TE7WWW - TEE

Nominal Size in.	Dimensions		Ordering Code
	A in.	A mm	
1/4	1.750	44.5	TE7WWW6L.25-..
3/8	1.750	44.5	TE7WWW6L.375-..
1/2	1.875	47.6	TE7WWW6L.5-..
3/4	2.000	50.8	TE7WWW6L.75-..
1	2.125	54.0	TE7WWW6L1.0-..
1 1/2	2.375	60.3	TE7WWW6L1.5-..
2	2.875	73.0	TE7WWW6L2.0-..
2 1/2	3.125	79.4	TE7WWW6L2.5-..
3	3.375	85.7	TE7WWW6L3.0-..
4	4.125	104.8	TE7WWW6L4.0-..
6	5.625	142.9	TE7WWW6L6.0-..

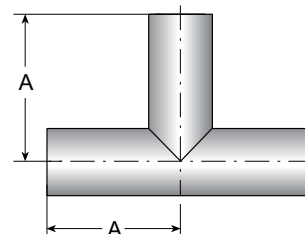

BPE TABLE # DT-4.1.2-1

TE7WWC - TEE

Nominal Size in.	Dimensions						Ordering Code
	A in.	A mm	B in.	B mm	C in.	C mm	
1/2	1.875	47.6	2.250	57.20	3.750	95.2	TE7WWC6L.5-..
3/4	2.000	50.8	2.375	60.30	4.000	101.6	TE7WWC6L.75-..
*1	2.125	54.0	2.625	66.68	4.250	108.0	TE7WWC6L1.0-..
1 1/2	2.375	60.3	2.875	73.03	4.750	120.6	TE7WWC6L1.5-..
2	2.875	73.0	3.375	85.70	5.750	146.0	TE7WWC6L2.0-..
2 1/2	3.125	79.4	3.625	92.08	6.250	158.8	TE7WWC6L2.5-..
3	3.375	85.7	3.875	98.43	6.750	171.4	TE7WWC6L3.0-..
4	4.125	104.8	4.750	120.65	8.250	209.6	TE7WWC6L4.0-..
6	5.625	142.9	7.125	181.0	11.250	285.8	TE7WWC6L6.0-..

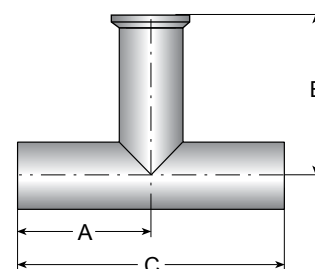

* Note: 1" Clamp Ferrule can also be order with "Type A" connections according to the ASME BPE standard.

TEG7 - TEE

Nominal Size in.	Dimensions		Ordering Code
	A in.	A mm	
1/4	2.250	57.2	TEG76L.25-..
3/8	2.250	57.2	TEG76L.375-..
1/2	2.250	57.2	TEG76L.5-..
3/4	2.375	60.3	TEG76L.75-..
*1	2.625	66.7	TEG76L1.0-..
1 1/2	2.875	73.0	TEG76L1.5-..
2	3.375	85.7	TEG76L2.0-..
2 1/2	3.625	92.1	TEG76L2.5-..
3	3.875	98.4	TEG76L3.0-..
4	4.750	120.7	TEG76L4.0-..
6	7.125	181.0	TEG76L6.0-..

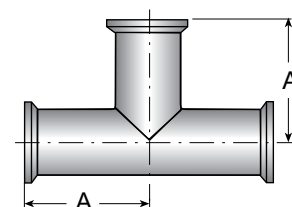

BPE TABLE # DT-4.1.2-4

* Note: 1" Clamp Ferrule can also be order with "Type A" connections according to the ASME BPE standard.

Tees - 88°

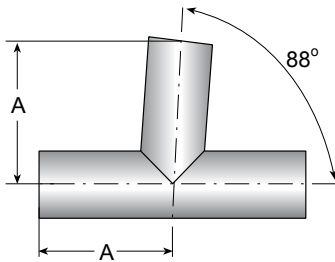

TE7WWW886L - BRANCH TEE 88°

Nominal Size in.	Dimensions		Ordering Code
	A in.	A mm	
1	2.125	54	TE7WWW886L1.0-..
1½	2.375	60.3	TE7WWW886L1.5-..
2	2.875	73	TE7WWW886L2.0-..
2½	3.125	79.4	TE7WWW886L2.5-..
3	3.375	85.7	TE7WWW886L3.0-..
4	4.125	104.8	TE7WWW886L4.0-..

Note: Reducing sizes and special end configurations can be supplied upon request.

TEES - 176°

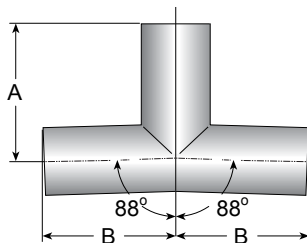

TE7WWW1766L - 176° RUN TEE

Nominal Size in.	Dimensions				Ordering Code
	A in.	A mm	B in.	B mm	
1	2.2	55.88	2.12	53.848	TE7WWW1766L1.0-..
1½	2.46	62.484	2.37	60.198	TE7WWW1766L1.5-..
2	2.98	75.692	2.87	72.898	TE7WWW1766L2.0-..
2½	3.24	82.296	3.12	79.248	TE7WWW1766L2.5-..
3	3.5	88.9	3.73	94.742	TE7WWW1766L3.0-..
4	4.27	108.458	4.12	104.648	TE7WWW1766L4.0-..

Note: Reducing sizes and special end configurations can be supplied upon request.

Tees - Short Outlet

TE7WWCS - SHORT OUTLET TEE

Nominal Size in.	Dimensions				Ordering Code
	A in.	A mm	B in.	B mm	
1/4	1.750	44.5	1.000	25.4	TE7WWCS6L.25-..
3/8	1.750	44.5	1.000	25.4	TE7WWCS6L.375-..
1/2	1.875	47.6	1.000	25.4	TE7WWCS6L.5-..
3/4	2.000	50.8	1.125	28.6	TE7WWCS6L.75-..
*1	2.125	54.0	1.125	28.6	TE7WWCS6L1.0-..
1 1/2	2.375	60.3	1.375	34.9	TE7WWCS6L1.5-..
2	2.875	73.0	1.625	41.3	TE7WWCS6L2.0-..
2 1/2	3.125	79.4	1.875	47.6	TE7WWCS6L2.5-..
3	3.375	85.7	2.125	54.0	TE7WWCS6L3.0-..
4	4.125	104.8	2.750	69.9	TE7WWCS6L4.0-..
6	5.625	142.9	4.625	117.5	TE7WWCS6L6.0-..

* **Note:** 1" Clamp Ferrule can also be orderd with "Type A" connections according to the ASME BPE standard.

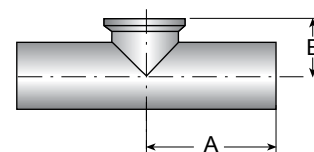

BPE TABLE # DT-4.1.2-2

TE7WCSW - SHORT OUTLET RUN TEE

Nominal Size in.	Dimensions						Ordering Code
	A in.	A mm	B in.	B mm	C in.	C mm	
1/4	0.875	22.2	1.750	44.5	1.750	44.5	TE7WCSW6L.25-..
3/8	0.875	22.2	1.750	44.5	1.750	44.5	TE7WCSW6L.375-..
1/2	0.875	22.2	1.875	47.6	1.875	47.6	TE7WCSW6L.5-..
3/4	1.000	25.4	2.000	50.8	2.000	50.8	TE7WCSW6L.75-..
*1	1.125	28.6	2.125	54.0	2.125	54.0	TE7WCSW6L1.0-..
1 1/2	1.375	34.9	2.375	60.3	2.375	60.3	TE7WCSW6L1.5-..
2	1.625	41.3	2.875	73.0	2.875	73.0	TE7WCSW6L2.0-..
2 1/2	1.875	47.6	3.125	79.4	3.125	79.4	TE7WCSW6L2.5-..
3	2.125	54.0	3.375	85.7	3.375	85.7	TE7WCSW6L3.0-..
4	2.750	69.9	4.125	104.8	4.125	104.8	TE7WCSW6L4.0-..
6	4.625	117.5	5.625	142.9	5.625	142.9	TE7WCSW6L6.0-..

* **Note:** 1" Clamp Ferrule can also be orderd with "Type A" connections according to the ASME BPE standard.

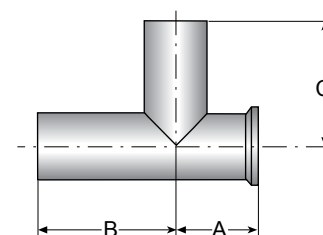

BPE TABLE # DT-4.1.2-3

TEG7S - SHORT OUTLET TEE

Nominal Size in.	Dimensions				Ordering Code
	A in.	A mm	B in.	B mm	
1/2	2.250	57.2	1.000	25.4	TEG7S6L.5-..
3/4	2.375	60.3	1.125	28.6	TEG7S6L.75-..
*1	2.625	66.7	1.125	28.6	TEG7S6L1.0-..
1 1/2	2.875	73.0	1.375	34.9	TEG7S6L1.5-..
2	3.375	85.7	1.625	41.3	TEG7S6L2.0-..
2 1/2	3.625	92.1	1.875	47.6	TEG7S6L2.5-..
3	3.875	98.4	2.125	54.0	TEG7S6L3.0-..
4	4.750	120.7	2.750	69.9	TEG7S6L4.0-..
6	7.125	181.0	4.625	117.5	TEG7S6L6.0-..

* **Note:** 1" Clamp Ferrule can also be orderd with "Type A" connections according to the ASME BPE standard.

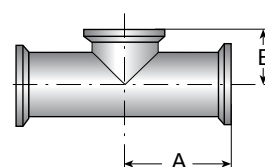

BPE TABLE # DT-4.1.2-5

Tees - Reducing

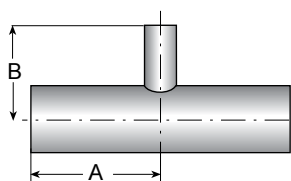

BPE TABLE # DT-4.1.2-6

TE7RWWW - REDUCING TEE

Nominal Size in.	Dimensions				Ordering Code
	A in.	A mm	B in.	B mm	
3/8 x 1/4	1.750	44.5	1.750	44.5	TE7RWWW6L.375x.25-..
1/2 x 1/4	1.875	47.6	1.875	47.6	TE7RWWW6L.5x.25-..
1/2 x 3/8	1.875	47.6	1.875	47.6	TE7RWWW6L.5x.375-..
3/4 x 1/4	2.000	50.8	2.000	50.8	TE7RWWW6L.75x.25-..
3/4 x 3/8	2.000	50.8	2.000	50.8	TE7RWWW6L.75x.375-..
3/4 x 1/2	2.000	50.8	2.000	50.8	TE7RWWW6L.75x.5-..
1 x 1/4	2.125	54.0	2.125	54.0	TE7RWWW6L1.0x.25-..
1 x 3/8	2.125	54.0	2.125	54.0	TE7RWWW6L1.0x.375-..
1 x 1/2	2.125	54.0	2.125	54.0	TE7RWWW6L1.0x.5-..
1 x 3/4	2.125	54.0	2.125	54.0	TE7RWWW6L1.0x.75-..
1 1/2 x 1/2	2.375	60.3	2.375	60.3	TE7RWWW6L1.5x.5-..
1 1/2 x 3/4	2.375	60.3	2.375	60.3	TE7RWWW6L1.5x.75-..
1 1/2 x 1	2.375	60.3	2.375	60.3	TE7RWWW6L1.5x1.0-..
2 x 1/2	2.875	73.0	2.625	66.7	TE7RWWW6L2.0x.5-..
2 x 3/4	2.875	73.0	2.625	66.7	TE7RWWW6L2.0x.75-..
2 x 1	2.875	73.0	2.625	66.7	TE7RWWW6L2.0x1.0-..
2 x 1 1/2	2.875	73.0	2.625	66.7	TE7RWWW6L2.0x1.5-..
2 1/2 x 1/2	3.125	79.4	2.875	73.0	TE7RWWW6L2.5x.5-..
2 1/2 x 3/4	3.125	79.4	2.875	73.0	TE7RWWW6L2.5x.75-..
2 1/2 x 1	3.125	79.4	2.875	73.0	TE7RWWW6L2.5x1.0-..
2 1/2 x 1 1/2	3.125	79.4	2.875	73.0	TE7RWWW6L2.5x1.5-..
2 1/2 x 2	3.125	79.4	2.875	73.0	TE7RWWW6L2.5x2.0-..
3 x 1/2	3.375	85.7	3.125	79.4	TE7RWWW6L3.0x.5-..
3 x 3/4	3.375	85.7	3.125	79.4	TE7RWWW6L3.0x.75-..
3 x 1	3.375	85.7	3.125	79.4	TE7RWWW6L3.0x1.0-..
3 x 1 1/2	3.375	85.7	3.125	79.4	TE7RWWW6L3.0x1.5-..
3 x 2	3.375	85.7	3.125	79.4	TE7RWWW6L3.0x2.0-..
3 x 2 1/2	3.375	85.7	3.125	79.4	TE7RWWW6L3.0x2.5-..
4 x 1/2	4.125	104.8	3.625	92.1	TE7RWWW6L4.0x.5-..
4 x 3/4	4.125	104.8	3.625	92.1	TE7RWWW6L4.0x.75-..
4 x 1	4.125	104.8	3.625	92.1	TE7RWWW6L4.0x1.0-..
4 x 1 1/2	4.125	104.8	3.625	92.1	TE7RWWW6L4.0x1.5-..
4 x 2	4.125	104.8	3.875	98.4	TE7RWWW6L4.0x2.0-..
4 x 2 1/2	4.125	104.8	3.875	98.4	TE7RWWW6L4.0x2.5-..
4 x 3	4.125	104.8	3.875	98.4	TE7RWWW6L4.0x3.0-..
6 x 3	5.625	142.9	4.875	123.8	TE7RWWW6L6.0x3.0-..
6 x 4	5.625	142.9	5.125	130.2	TE7RWWW6L6.0x4.0-..

Tees - Reducing

TE7RWWC - REDUCING TEE

Nominal Size in.	Dimensions				Ordering Code
	A in.	A mm	B in.	B mm	
3/4 x 1/2	2.000	50.8	2.500	63.5	TE7RWWC6L.75x.5-..
* 1 x 1/2	2.125	54.0	2.625	66.7	TE7RWWC6L1.0x.5-..
* 1 x 3/4	2.125	54.0	2.625	66.7	TE7RWWC6L1.0x.75-..
1 1/2 x 1/2	2.375	60.3	2.875	73.0	TE7RWWC6L1.5x.5-..
1 1/2 x 3/4	2.375	60.3	2.875	73.0	TE7RWWC6L1.5x.75-..
1 1/2 x 1*	2.375	60.3	2.875	73.0	TE7RWWC6L1.5x1.0-..
2 x 1/2	2.875	73.0	3.125	79.4	TE7RWWC6L2.0x.5-..
2 x 3/4	2.875	73.0	3.125	79.4	TE7RWWC6L2.0x.75-..
2 x 1*	2.875	73.0	3.125	79.4	TE7RWWC6L2.0x1.0-..
2 x 1 1/2	2.875	73.0	3.125	79.4	TE7RWWC6L2.0x1.5-..
2 1/2 x 1/2	3.125	79.4	3.375	85.7	TE7RWWC6L2.5x.5-..
2 1/2 x 1 1/2	3.125	79.4	3.375	85.7	TE7RWWC6L2.5x1.5-..
2 1/2 x 2	3.125	79.4	3.375	85.7	TE7RWWC6L2.5x2.0-..
3 x 1*	3.375	85.7	3.625	92.1	TE7RWWC6L3.0x1.0-..
3 x 1 1/2	3.375	85.7	3.625	92.1	TE7RWWC6L3.0x1.5-..
3 x 2	3.375	85.7	3.625	92.1	TE7RWWC6L3.0x2.0-..
3 x 2 1/2	3.375	85.7	3.625	92.1	TE7RWWC6L3.0x2.5-..
4 x 1*	4.125	104.8	4.125	104.8	TE7RWWC6L4.0x1.0-..
4 x 1 1/2	4.125	104.8	4.125	104.8	TE7RWWC6L4.0x1.5-..
4 x 2	4.125	104.8	4.375	111.1	TE7RWWC6L4.0x2.0-..
4 x 2 1/2	4.125	104.8	4.375	111.1	TE7RWWC6L4.0x2.5-..
4 x 3	4.125	104.8	4.375	111.1	TE7RWWC6L4.0x3.0-..
6 x 3	5.625	142.9	5.375	136.5	TE7RWWC6L6.0x3.0-..
6 x 4	5.625	142.9	5.750	146.1	TE7RWWC6L6.0x4.0-..

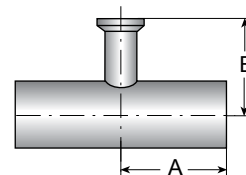

* **Note:** 1" Clamp Ferrule can also be orderd with "Type A" connections according to the ASME BPE standard.



Tees - Reducing

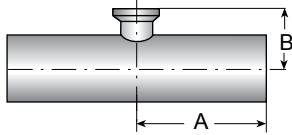

BPE TABLE # DT-4.1.2-7

TE7RWWCS-SHORT OUTLET REDUCING TEE

Nominal Size in.	Dimensions				Ordering Code
	A in.	A mm	B in.	B mm	
3/8 x 1/4	1.750	44.5	1.000	25.4	TE7RWWCS6L.375x.25-..
1/2 x 1/4	1.875	47.6	1.000	25.4	TE7RWWCS6L.5x.25-..
1/2 x 3/8	1.875	47.6	1.000	25.4	TE7RWWCS6L.5x.375-..
3/4 x 1/4	2.000	50.8	1.000	25.4	TE7RWWCS6L.75x.25-..
3/4 x 3/8	2.000	50.8	1.000	25.4	TE7RWWCS6L.75x.375-..
3/4 x 1/2	2.000	50.8	1.000	25.4	TE7RWWCS6L.75x.5-..
1 x 1/4	2.125	54.0	1.125	28.6	TE7RWWCS6L1.0x.5-..
1 x 3/8	2.125	54.0	1.125	28.6	TE7RWWCS6L1.0x.375
1 x 1/2	2.125	54.0	1.125	28.6	TE7RWWCS6L1.0x.5-..
1 x 3/4	2.125	54.0	1.125	28.6	TE7RWWCS6L1.0x.75-..
1 1/2 x 1/2	2.375	60.3	1.375	34.9	TE7RWWCS6L1.5x.5-..
1 1/2 x 3/4	2.375	60.3	1.375	34.9	TE7RWWCS6L1.5x.75-..
1 1/2 x 1*	2.375	60.3	1.375	34.9	TE7RWWCS6L1.5x1.0-..
2 x 1/2	2.875	73.0	1.625	41.3	TE7RWWCS6L2.0x.5-..
2 x 3/4	2.875	73.0	1.625	41.3	TE7RWWCS6L2.0x.75-..
2 x 1*	2.875	73.0	1.625	41.3	TE7RWWCS6L2.0x1.0-..
2 x 1 1/2	2.875	73.0	1.625	41.3	TE7RWWCS6L2.0x1.5-..
2 1/2 x 1/2	3.125	79.4	1.875	47.6	TE7RWWCS6L2.5x.5-..
2 1/2 x 3/4	3.125	79.4	1.875	47.6	TE7RWWCS6L2.5x.75-..
2 1/2 x 1*	3.125	79.4	1.875	47.6	TE7RWWCS6L2.5x1.0-..
2 1/2 x 1 1/2	3.125	79.4	1.875	47.6	TE7RWWCS6L2.5x1.5-..
2 1/2 x 2	3.125	79.4	1.875	47.6	TE7RWWCS6L2.5x2.0-..
3 x 1/2	3.375	85.7	2.125	54.0	TE7RWWCS6L4.0x.5-..
3 x 3/4	3.375	85.7	2.125	54.0	TE7RWWCS6L4.0x.75-..
3 x 1*	3.375	85.7	2.125	54.0	TE7RWWCS6L3.0x1.0-..
3 x 1 1/2	3.375	85.7	2.125	54.0	TE7RWWCS6L3.0x1.5-..
3 x 2	3.375	85.7	2.125	54.0	TE7RWWCS6L3.0x2.0-..
3 x 2 1/2	3.375	85.7	2.125	54.0	TE7RWWCS6L3.0x2.5-..
4 x 1/2	4.125	104.8	2.625	66.7	TE7RWWCS6L3.0x.5-..
4 x 3/4	4.125	104.8	2.625	66.7	TE7RWWCS6L3.0x.75-..
4 x 1*	4.125	104.8	2.625	66.7	TE7RWWCS6L4.0x1.0-..
4 x 1 1/2	4.125	104.8	2.625	66.7	TE7RWWCS6L4.0x1.5-..
4 x 2	4.125	104.8	2.625	66.7	TE7RWWCS6L4.0x2.0-..
4 x 2 1/2	4.125	104.8	2.625	66.7	TE7RWWCS6L4.0x2.5-..
4 x 3	4.125	104.8	2.625	66.7	TE7RWWCS6L4.0x3.0-..
6 x 1/2	5.625	142.9	3.625	92.1	TE7RWWCS6L6.0x.5-..
6 x 3/4	5.625	142.9	3.625	92.1	TE7RWWCS6L6.0x.75-..
6 x 1*	5.625	142.9	3.625	92.1	TE7RWWCS6L6.0x1.0-..
6 x 1 1/2	5.625	142.9	3.625	92.1	TE7RWWCS6L6.0x1.5-..
6 x 2	5.625	142.9	3.625	92.1	TE7RWWCS6L6.0x2.0-..
6 x 2 1/2	5.625	142.9	3.625	92.1	TE7RWWCS6L6.0x2.5-..
6 x 3	5.625	142.9	3.625	92.1	TE7RWWCS6L6.0x3.0-..
6 x 4	5.625	142.9	3.750	95.3	TE7RWWCS6L6.0x4.0-..

Note: Additional sizes are available upon request.

* **Note:** 1" Clamp Ferrule can also be ordered with "Type A" connections according to the ASME BPE standard.

Tees - Reducing

TEG7R - REDUCING TEE

Nominal Size in.	Dimensions				Ordering Code
	A in.	A mm	B in.	B mm	
3/8 x 1/4	2.250	57.2	2.250	57.2	TEG7R6L3.75x.25-..
1/2 x 1/4	2.375	60.3	2.375	60.3	TEG7R6L.5x.25-..
1/2 x 3/8	2.375	60.3	2.375	60.3	TEG7R6L.5x.375-..
3/4 x 1/4	2.500	63.5	2.500	63.5	TEG7R6L.75x.25-..
3/4 x 3/8	2.500	63.5	2.500	63.5	TEG7R6L.75x.375-..
3/4 x 1/2	2.500	63.5	2.500	63.5	TEG7R6L.75x.5-..
* 1 x 1/4	2.625	66.7	2.625	66.7	TEG7R6L1.0x.25-..
* 1 x 3/8	2.625	66.7	2.625	66.7	TEG7R6L1.0x.375-..
* 1 x 1/2	2.625	66.7	2.625	66.7	TEG7R6L1.0X.5-..
* 1 x 3/4	2.625	66.7	2.625	66.7	TEG7R6L1.0x.75-..
1 1/2 x 1/2	2.875	73.0	2.875	73.0	TEG7R6L1.5X.5-..
1 1/2 x 3/4	2.875	73.0	2.875	73.0	TEG7R6L1.5x.75-..
1 1/2 x 1*	2.875	73.0	2.875	73.0	TEG7R6L1.5X1.0-..
2 x 1/2	3.375	85.7	3.125	79.4	TEG7R6L2.0X.5-..
2 x 3/4	3.375	85.7	3.125	79.4	TEG7R6L2.0x.75-..
2 x 1*	3.375	85.7	3.125	79.4	TEG7R6L2.0X1.0-..
2 x 1 1/2	3.375	85.7	3.125	79.4	TEG7R6L2.0X1.5-..
2 1/2 x 1/2	3.625	92.1	3.375	85.7	TEG7R6L2.5X.5-..
2 1/2 x 3/4	3.625	92.1	3.375	85.7	TEG7R6L2.5x.75-..
2 1/2 x 1*	3.625	92.1	3.375	85.7	TEG7R6L2.5X1.0-..
2 1/2 x 1 1/2	3.625	92.1	3.375	85.7	TEG7R6L2.5X1.5-..
2 1/2 x 2	3.625	92.1	3.375	85.7	TEG7R6L2.5X2.0-..
3 x 1/2	3.875	98.4	3.625	92.1	TEG7R6L3.0X.5-..
3 x 3/4	3.875	98.4	3.625	92.1	TEG7R6L3.0x.75-..
3 x 1*	3.875	98.4	3.625	92.1	TEG7R6L3.0X1.0-..
3 x 1 1/2	3.875	98.4	3.625	92.1	TEG7R6L3.0X1.5-..
3 x 2	3.875	98.4	3.625	92.1	TEG7R6L3.0X2.0-..
3 x 2 1/2	3.875	98.4	3.625	92.1	TEG7R6L3.0X2.5-..
4 x 1/2	4.750	120.7	4.125	104.8	TEG7R6L4.0X.5-..
4 x 3/4	4.750	120.7	4.125	104.8	TEG7R6L4.0x.75-..
4 x 1*	4.750	120.7	4.125	104.8	TEG7R6L4.0X1.0-..
4 x 1 1/2	4.750	120.7	4.125	104.8	TEG7R6L4.0X1.5-..
4 x 2	4.750	120.7	4.375	111.1	TEG7R6L4.0X2.0-..
4 x 2 1/2	4.750	120.7	4.375	111.1	TEG7R6L4.0X2.5-..
4 x 3	4.750	120.7	4.375	111.1	TEG7R6L4.0X3.0-..
6 x 3	7.125	181.0	5.375	136.5	TEG7R6L6.0X3.0-..
6 x 4	7.125	181.0	5.750	146.1	TEG7R6L6.0X4.0-..

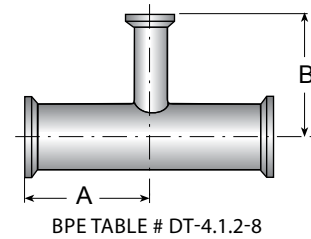

* Note: 1" Clamp Ferrule can also be orderd with "Type A" connections according to the ASME BPE standard.

Tees - Reducing

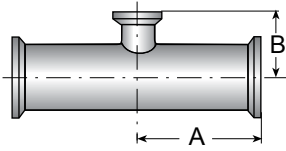

BPE TABLE # DT-4.1.2-9

TEG7RS-SHORT OUTLET REDUCING TEE

Nominal Size in.	Dimensions				Ordering Code
	A in.	A mm	B in.	B mm	
3/8 x 1/4	2.250	57.2	1.000	25.4	TEG7RS6L.375x.25-..
1/2 x 1/4	2.375	60.3	1.000	25.4	TEG7RS6L.5x.25-..
1/2 x 3/8	2.375	60.3	1.000	25.4	TEG7RS6L.5x.375-..
3/4 x 1/4	2.500	63.5	1.000	25.4	TEG7RS6L.75x.25-..
3/4 x 3/8	2.500	63.5	1.000	25.4	TEG7RS6L.75x.375-..
3/4 x 1/2	2.500	63.5	1.000	25.4	TEG7RS6L.75x.5-..
* 1 x 1/4	2.625	66.7	1.125	28.6	TEG7RS6L1.0x.25-..
* 1 x 3/8	2.625	66.7	1.125	28.6	TEG7RS6L1.0x.375-..
* 1 x 1/2	2.625	66.7	1.125	28.6	TEG7RS6L1.0x.5-..
* 1 x 3/4	2.625	66.7	1.125	28.6	TEG7RS6L1.0x.75-..
1 1/2 x 1/2	2.875	73.0	1.375	34.9	TEG7RS6L1.5x.5-..
1 1/2 x 3/4	2.875	73.0	1.375	34.9	TEG7RS6L1.5x.75-..
1 1/2 x 1*	2.875	73.0	1.375	34.9	TEG7RS6L1.5x.1.0-..
2 x 1/2	3.375	85.7	1.625	41.3	TEG7RS6L2.0x.5-..
2 x 3/4	3.375	85.7	1.625	41.3	TEG7RS6L2.0x.75-..
2 x 1*	3.375	85.7	1.625	41.3	TEG7RS6L2.0x1.0-..
2 x 1 1/2	3.375	85.7	1.625	41.3	TEG7RS6L2.0x1.5-..
2 1/2 x 1/2	3.625	92.1	1.875	47.6	TEG7RS6L2.5x.5-..
2 1/2 x 3/4	3.625	92.1	1.875	47.6	TEG7RS6L2.5x.75-..
2 1/2 x 1*	3.625	92.1	1.875	47.6	TEG7RS6L2.5x1.0-..
2 1/2 x 1 1/2	3.625	92.1	1.875	47.6	TEG7RS6L2.5x1.5-..
2 1/2 x 2	3.625	92.1	1.875	47.6	TEG7RS6L2.5x2.0-..
3 x 1/2	3.875	98.4	2.125	54.0	TEG7RS6L3.0x.5-..
3 x 3/4	3.875	98.4	2.125	54.0	TEG7RS6L3.0x.75-..
3 x 1*	3.875	98.4	2.125	54.0	TEG7RS6L3.0x1.0-..
3 x 1 1/2	3.875	98.4	2.125	54.0	TEG7RS6L3.0x1.5-..
3 x 2	3.875	98.4	2.125	54.0	TEG7RS6L3.0x2.0-..
3 x 2 1/2	3.875	98.4	2.125	54.0	TEG7RS6L3.0x2.5-..
4 x 1/2	4.750	120.7	2.625	66.7	TEG7RS6L4.0x.5-..
4 x 3/4	4.750	120.7	2.625	66.7	TEG7RS6L4.0x.75-..
4 x 1*	4.750	120.7	2.625	66.7	TEG7RS6L4.0x1.0-..
4 x 1 1/2	4.750	120.7	2.625	66.7	TEG7RS6L4.0x1.5-..
4 x 2	4.750	120.7	2.625	66.7	TEG7RS6L4.0x2.0-..
4 x 2 1/2	4.750	120.7	2.625	66.7	TEG7RS6L4.0x2.5-..
4 x 3	4.750	120.7	2.625	66.7	TEG7RS6L4.0x3.0-..
6 x 1/2	7.125	181.0	3.625	92.1	TEG7RS6L6.0x.5-..
6 x 3/4	7.125	181.0	3.625	92.1	TEG7RS6L6.0x.75-..
6 x 1*	7.125	181.0	3.625	92.1	TEG7RS6L6.0x1.0-..
6 x 1 1/2	7.125	181.0	3.625	92.1	TEG7RS6L6.0x1.5-..
6 x 2	7.125	181.0	3.625	92.1	TEG7RS6L6.0x2.0-..
6 x 2 1/2	7.125	181.0	3.625	92.1	TEG7RS6L6.0x2.5-..
6 x 3	7.125	181.0	3.625	92.1	TEG7RS6L6.0x3.0-..
6 x 4	7.125	181.0	3.750	95.3	TEG7RS6L6.0x4.0-..

* **Note:** 1" Clamp Ferrule can also be orderd with "Type A" connections according to the ASME BPE standard.

Tees - Instrument

TE7IWWCS - INSTRUMENT TEE

Nominal Size in.	Dimensions				Ordering Code
	A in.	A mm	B in.	B mm	
1/2 x 1	2.250	57.15	1.000	25.40	TE7IWWCS6L.5x1.0-..
3/4 x 1	2.250	57.15	1.000	25.40	TE7IWWCS6L.75x1.0-..
1/2 x 1 1/2	2.500	63.5	0.875	22.2	TE7IWWCS6L.5x1.5-..
3/4 x 1 1/2	2.500	63.5	1.000	25.4	TE7IWWCS6L.75x1.5-..
1 x 1 1/2	2.500	63.5	1.125	28.6	TE7IWWCS6L1.0x1.5-..
1/2 x 2	2.750	69.9	1.000	25.4	TE7IWWCS6L.5x2.0-..
3/4 x 2	2.750	69.9	1.125	28.6	TE7IWWCS6L.75x2.0-..
1 x 2	2.750	69.9	1.250	31.8	TE7IWWCS6L1.0x2.0-..
1 1/2 x 2	2.750	69.9	1.500	38.1	TE7IWWCS6L1.5x2.0-..

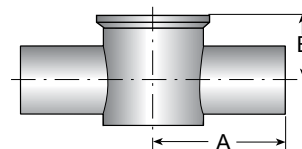

BPE TABLE # DT-4.1.2-10

TEG7IS - INSTRUMENT TEE

Nominal Size in.	Dimensions				Ordering Code
	A in.	A mm	B in.	B mm	
1/2 x 1 1/2	3.000	76.2	0.875	22.2	TEG7IS6L.5x1.5-..
3/4 x 1 1/2	3.000	76.2	1.000	25.4	TEG7IS6L.75x1.5-..
* 1 x 1 1/2	3.000	76.2	1.125	28.6	TEG7IS6L1.0x1.5-..
1/2 x 2	3.250	82.6	1.000	25.4	TEG7IS6L.5x2.0-..
3/4 x 2	3.250	82.6	1.125	28.6	TEG7IS6L.75x2.0-..
* 1 x 2	3.250	82.6	1.250	31.8	TEG7IS6L1.0x2.0-..
1 1/2 x 2	3.250	82.6	1.500	38.1	TEG7IS6L1.5x2.0-..

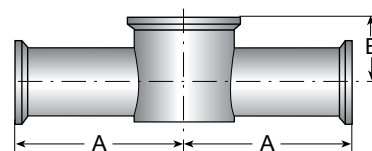

BPE TABLE # DT-4.1.2-11

* **Note:** 1" Clamp Ferrule can also be ordered with "Type A" connections according to the ASME BPE standard.

Reducers - Concentric

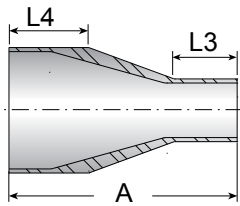

BPE TABLE # DT-4.1.3-1

TE31SWW - SHORT CONCENTRIC REDUCER

Nominal Size in.	Dimensions						Ordering Code
	Overall Length, A, in	Overall Length, A, mm	Minimum O.D. Tangent, Small End, L3, in.	Minimum O.D. Tangent, Small End, L3, mm	Minimum O.D. Tangent, Large End, L4, in.	Minimum O.D. Tangent, Large End, L4, mm.	
*3/8 x 1/4	1.625	41.275	0.750	19.05	0.750	19.05	TE31SWW6L375x.25-..
*1/2 x 1/4	1.875	47.625	0.750	19.05	1.000	25.4	TE31SWW6L5x.25-..
*1/2 x 3/8	1.875	47.625	0.750	19.05	1.000	25.4	TE31SWW6L5x.375-..
*3/4 x 3/8	2.000	50.8	0.750	19.05	1.000	25.4	TE31SWW6L.75x.375-..
3/4 x 1/2	2.125	53.975	1.000	25.4	1.000	25.4	TE31SWW6L.75x.5-..
1 x 1/2	2.500	63.5	1.000	25.4	1.000	25.4	TE31SWW6L1.0x.5-..
1 x 3/4	2.125	53.975	1.000	25.4	1.000	25.4	TE31SWW6L1.0x.75-..
1 1/2 x 3/4	3.000	76.2	1.000	25.4	1.000	25.4	TE31SWW6L1.5x.75-..
1 1/2 x 1	2.500	63.5	1.000	25.4	1.000	25.4	TE31SWW6L1.5x1.0-..
2 x 1	3.375	85.725	1.000	25.4	1.000	25.4	TE31SWW6L2.0x1.0-..
2 x 1 1/2	2.500	63.5	1.000	25.4	1.000	25.4	TE31SWW6L2.0x1.5-..
2 1/2 x 1 1/2	3.375	85.725	1.000	25.4	1.000	25.4	TE31SWW6L2.5x1.5-..
2 1/2 x 2	2.500	63.5	1.000	25.4	1.000	25.4	TE31SWW6L2.5x2.0-..
3 x 1 1/2	4.250	107.95	1.000	25.4	1.500	38.1	TE31SWW6L3.0x1.5-..
3 x 2	3.375	85.725	1.000	25.4	1.500	38.1	TE31SWW6L3.0x2.0-..
3 x 2 1/2	2.625	66.675	1.000	25.4	1.500	38.1	TE31SWW6L3.0x2.5-..
4 x 2	5.125	130.175	1.000	25.4	1.500	38.1	TE31SWW6L4.0x2.0-..
4 x 2 1/2	4.250	107.95	1.000	25.4	1.500	38.1	TE31SWW6L4.0x2.5-..
4 x 3	3.875	98.425	1.500	38.1	1.500	38.1	TE31SWW6L4.0x3.0-..
6 x 3	7.250	184.15	1.500	38.1	2.000	50.8	TE31SWW6L6.0x3.0-..
6 x 4	5.625	142.875	1.500	38.1	2.000	50.8	TE31SWW6L6.0x4.0-..

This product is available in PM and PL surface finishes only.

* **Note:** Available upon request.

Reducers - Concentric

TE31SCW - SHORT CONCENTRIC REDUCER

Nominal Size in.	Dimensions				Ordering Code
	Overall Length, A, in	Overall Length, A, mm	Minimum O.D. Tangent, Small End, L3, in.	Minimum O.D. Tangent, Small End, L3, mm	
*3/8 x 1/4	2.125	53.975	0.750	19.05	TE31SCW6L.375x.25-..
*1/2 x 1/4	2.375	60.325	0.750	19.05	TE31SCW6L.5x.25-..
*1/2 x 3/8	2.375	60.325	0.750	19.05	TE31SCW6L.5x.375-..
*3/4 x 3/8	2.500	63.5	0.750	19.05	TE31SCW6L.75x.375-..
3/4 x 1/2	2.625	66.675	1.000	25.4	TE31SCW6L.75x.5-..
1 x 1/2	3.000	76.2	1.000	25.4	TE31SCW6L1.0x.5-..
1 x 3/4	2.625	66.675	1.000	25.4	TE31SCW6L1.0x.75-..
1 1/2 x 3/4	3.500	88.9	1.000	25.4	TE31SCW6L1.5x.75-..
1 1/2 x 1	3.000	76.2	1.000	25.4	TE31SCW6L1.5x1.0-..
2 x 1	3.875	98.425	1.000	25.4	TE31SCW6L2.0x1.0-..
2 x 1 1/2	3.000	76.2	1.000	25.4	TE31SCW6L2.0x1.5-..
2 1/2 x 1 1/2	3.875	98.425	1.000	25.4	TE31SCW6L2.5x1.5-..
2 1/2 x 2	3.000	76.2	1.000	25.4	TE31SCW6L2.5x2.0-..
3 x 1 1/2	4.750	120.65	1.000	25.4	TE31SCW6L3.0x1.5-..
3 x 2	3.875	98.425	1.000	25.4	TE31SCW6L3.0x2.0-..
3 x 2 1/2	3.125	79.375	1.000	25.4	TE31SCW6L3.0x2.5-..
4 x 2	5.750	146.05	1.000	25.4	TE31SCW6L4.0x2.0-..
4 x 2 1/2	4.875	123.825	1.000	25.4	TE31SCW6L4.0x2.5-..
4 x 3	4.500	114.3	1.500	38.1	TE31SCW6L4.0x3.0-..
6 x 3	8.000	203.2	1.500	38.1	TE31SCW6L6.0x3.0-..
6 x 4	6.375	161.925	1.500	38.1	TE31SCW6L6.0x4.0-..

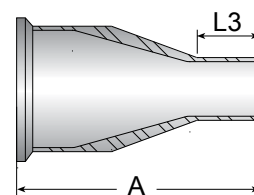

BPE TABLE # DT-4.1.3-2

This product is available in PM and PL surface finishes only.

* **Note:** Available upon request.

TEG31SCC - SHORT CONCENTRIC REDUCER

Nominal Size in.	Dimensions		Ordering Code
	Overall Length, A, in	Overall Length, A, mm	
* 3/8 x 1/4	2.625	66.675	TEG31SCC6I.375x.25
* 1/2 x 1/4	2.875	73.025	TEG31SCC6I.5x.25
* 1/2 x 3/8	2.875	73.025	TEG31SCC6I.5x.375
* 3/4 x 3/8	3.000	76.2	TEG31SCC6I.75x.375
3/4 x 1/2	3.125	79.375	TEG31SCC6I.75x.5
1 x 1/2	3.500	88.9	TEG31SCC6I1.0x.5
1 x 3/4	3.125	79.375	TEG31SCC6I1.0x.75
1 1/2 x 3/4	4.000	101.6	TEG31SCC6I1.5x.75
1 1/2 x 1	3.500	88.9	TEG31SCC6I1.5x1.0
2 x 1	4.375	111.125	TEG31SCC6I2.0x1.0
2 x 1 1/2	3.500	88.9	TEG31SCC6I2.0x1.5
2 1/2 x 1 1/2	4.375	111.125	TEG31SCC6I2.5x1.5
2 1/2 x 2	3.500	88.9	TEG31SCC6I2.5x2.0
3 x 1 1/2	5.250	133.35	TEG31SCC6I3.0x1.5
3 x 2	4.375	111.125	TEG31SCC6I3.0x2.0
3 x 2 1/2	3.625	92.075	TEG31SCC6I3.0x2.5
4 x 2	6.250	158.75	TEG31SCC6I4.0x2.0
4 x 2 1/2	5.375	136.525	TEG31SCC6I4.0x2.5
4 x 3	5.000	127	TEG31SCC6I4.0x3.0
6 x 3	8.500	215.9	TEG31SCC6I6.0x3.0
6 x 4	7.000	177.8	TEG31SCC6I6.0x4.0

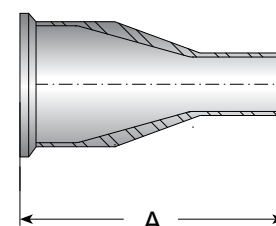

BPE TABLE # DT-4.1.3-3

This product is available in PM and PL surface finishes only.

* **Note:** Available upon request.

Reducers - Conical

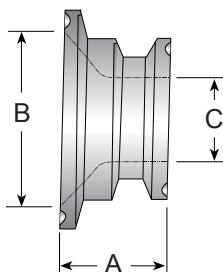

TEG31I - SHORT CONICAL INSTRUMENT REDUCER

Nominal Size in.	Dimensions						Ordering Code
	A in.	A mm	B in.	B mm	C in.	C mm	
3/4 x 1/2	1.250	31.75	0.620	15.748	0.370	9.398	TEG31L6L.75x.5 -..
1 x 1/2	1.250	31.75	0.870	22.098	0.370	9.398	TEG31L6L1.0x.5 -..
1 x 3/4	1.250	31.75	0.870	22.098	0.620	15.748	TEG31L6L1.0x.75 -..
1 1/2 x 1/2	1.250	31.75	1.370	34.798	0.370	9.398	TEG31L6L1.5x.5 -..
1 1/2 x 3/4	1.250	31.75	1.370	34.798	0.620	15.748	TEG31L6L1.5x.75 -..
1 1/2 x 1	1.250	31.75	1.370	34.798	0.870	22.098	TEG31L6L1.5x1.0 -..
2 x 1/2	1.250	31.75	1.870	47.498	0.370	9.398	TEG31L6L2.0x.5 -..
2 x 3/4	1.250	31.75	1.870	47.498	0.620	15.748	TEG31L6L2.0x.75 -..
2 x 1	1.250	31.75	1.870	47.498	0.870	22.098	TEG31L6L2.0x1.0 -..
2 x 1 1/2	1.250	31.75	1.870	47.498	1.370	34.798	TEG31L6L2.0x1.5 -..
2 1/2 x 1/2	1.250	31.75	2.370	60.198	0.370	9.398	TEG31L6L2.5x.5 -..
2 1/2 x 3/4	1.250	31.75	2.370	60.198	0.620	15.748	TEG31L6L2.5x.75 -..
2 1/2 x 1	1.250	31.75	2.370	60.198	0.870	22.098	TEG31L6L2.5x1.0 -..
2 1/2 x 1 1/2	1.250	31.75	2.370	60.198	1.370	34.798	TEG31L6L2.5x1.5 -..
2 1/2 x 2	1.250	31.75	2.370	60.198	1.870	47.498	TEG31L6L2.5x2.0 -..
3 x 1/2	1.250	31.75	2.870	72.898	0.370	9.398	TEG31L6L3.0x.5 -..
3 x 3/4	1.250	31.75	2.870	72.898	0.620	15.748	TEG31L6L3.0x.75 -..
3 x 1	1.250	31.75	2.870	72.898	0.870	22.098	TEG31L6L3.0x1.0 -..
3 x 1 1/2	1.250	31.75	2.870	72.898	1.370	34.798	TEG31L6L3.0x1.5 -..
3 x 2	1.250	31.75	2.870	72.898	1.870	47.498	TEG31L6L3.0x2.0 -..
3 x 2 1/2	1.250	31.75	2.870	72.898	2.370	60.198	TEG31L6L3.0x2.5 -..
4 x 1/2	1.250	31.75	3.834	97.384	0.370	9.398	TEG31L6L4.0x.5 -..
4 x 3/4	1.250	31.75	3.834	97.384	0.620	15.748	TEG31L6L4.0x.75 -..
4 x 1	1.250	31.75	3.834	97.384	0.870	22.098	TEG31L6L4.0x1.0 -..
4 x 1 1/2	1.250	31.75	3.834	97.384	1.370	34.798	TEG31L6L4.0x1.5 -..
4 x 2	1.250	31.75	3.834	97.384	1.870	47.498	TEG31L6L4.0x2.0 -..
4 x 2 1/2	1.250	31.75	3.834	97.384	2.370	60.198	TEG31L6L4.0x2.5 -..
4 x 3	1.250	31.75	3.834	97.384	2.870	72.898	TEG31L6L4.0x3.0 -..

Note: All reducers sizes are 1.250 overall length.

Reducers - Eccentric

TE32SWW - SHORT ECCENTRIC REDUCER

Nominal Size in.	Dimensions		Minimum O.D.				Ordering Code
	Overall Length, A, in	Overall Length, A, mm	Tangent, Small End, L3, in.	Tangent, Small End, L3, mm	Tangent, Large End, L4, in.	Tangent, Large End, L4, mm	
* 3/8 x 1/4	1.625	41.275	0.750	19.05	0.750	19.05	TE32SWW6L.375x.25-..
* 1/2 x 1/4	1.875	47.625	0.750	19.05	1.000	25.4	TE32SWW6L.5x.25-..
* 1/2 x 3/8	1.875	47.625	0.750	19.05	1.000	25.4	TE32SWW6L.5x.375-..
* 3/4 x 3/8	2.000	50.8	0.750	19.05	1.000	25.4	TE32SWW6L.75x.375-..
3/4 x 1/2	2.125	53.975	1.000	25.4	1.000	25.4	TE32SWW6L.375x.5-..
1 x 1/2	2.500	63.5	1.000	25.4	1.000	25.4	TE32SWW6L1.0x.5-..
1 x 3/4	2.125	53.975	1.000	25.4	1.000	25.4	TE32SWW6L1.0x.75-..
1 1/2 x 3/4	3.000	76.2	1.000	25.4	1.000	25.4	TE32SWW6L1.5x.75-..
1 1/2 x 1	2.500	63.5	1.000	25.4	1.000	25.4	TE32SWW6L1.5x1.0-..
2 x 1	3.375	85.725	1.000	25.4	1.000	25.4	TE32SWW6L2.0x1.0-..
2 x 1 1/2	2.500	63.5	1.000	25.4	1.000	25.4	TE32SWW6L2.0x1.5-..
2 1/2 x 1 1/2	3.375	85.725	1.000	25.4	1.000	25.4	TE32SWW6L2.5x1.5-..
2 1/2 x 2	2.500	63.5	1.000	25.4	1.000	25.4	TE32SWW6L2.5x2.0-..
3 x 1 1/2	4.250	107.95	1.000	25.4	1.500	38.1	TE32SWW6L3.0x1.5-..
3 x 2	3.375	85.725	1.000	25.4	1.500	38.1	TE32SWW6L3.0x2.0-..
3 x 2 1/2	2.625	66.675	1.000	25.4	1.500	38.1	TE32SWW6L3.0x2.5-..
4 x 2	5.125	130.175	1.000	25.4	1.500	38.1	TE32SWW6L4.0x2.0-..
4 x 2 1/2	4.250	107.95	1.000	25.4	1.500	38.1	TE32SWW6L4.0x2.5-..
4 x 3	3.875	98.425	1.500	38.1	1.500	38.1	TE32SWW6L4.0x3.0-..
6 x 3	7.250	184.15	1.500	38.1	2.000	50.8	TE32SWW6L6.0x3.0-..
6 x 4	5.625	142.875	1.500	38.1	2.000	50.8	TE32SWW6L6.0x4.0-..

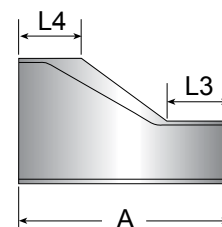

BPE TABLE # DT-4.1.3-1

This product is available in PM and PL surface finishes only.

* **Note:** Available upon request.

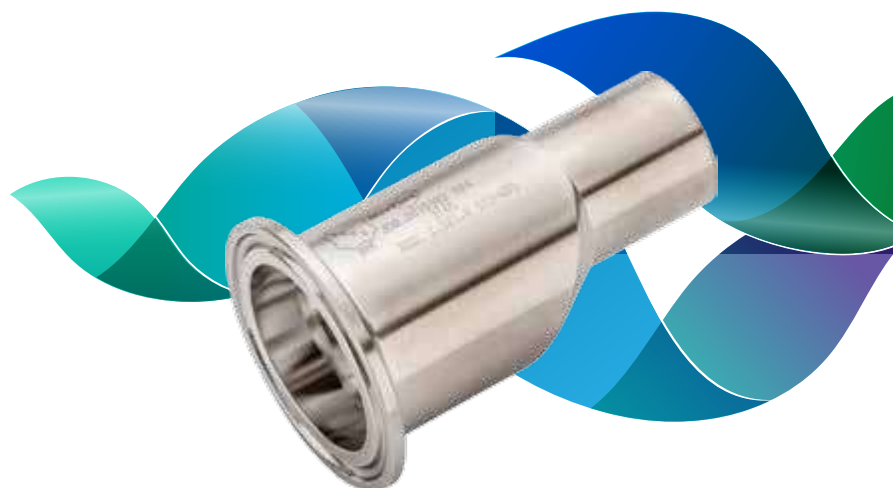

Reducers - Eccentric

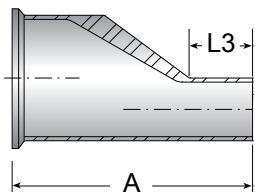

BPE TABLE # DT-4.1.3-2

TE32SCW - SHORT ECCENTRIC REDUCER

Nominal Size in.	Dimensions				Ordering Code
	Overall Length, A, in	Overall Length, A, mm	Minimum O.D. Tangent, Small End, L3, in.	Minimum O.D. Tangent, Small End, L3, mm.	
* 3/8 x 1/4	2.125	53.975	0.750	19.05	TE32SCW6L.375x.25-..
* 1/2 x 1/4	2.375	60.325	0.750	19.05	TE32SCW6L.5x.25-..
* 1/2 x 3/8	2.375	60.325	0.750	19.05	TE32SCW6L.5x.375-..
* 3/4 x 3/8	2.500	63.5	0.750	19.05	TE32SCW6L.75x.375-..
3/4 x 1/2	2.625	66.675	1.000	25.4	TE32SCW6L.75x.5-..
1 x 1/2	3.000	76.2	1.000	25.4	TE32SCW6L1.0x.5-..
1 x 3/4	2.625	66.675	1.000	25.4	TE32SCW6L1x.75-..
1 1/2 x 3/4	3.500	88.9	1.000	25.4	TE32SCW6L1.5x.75-..
1 1/2 x 1	3.000	76.2	1.000	25.4	TE32SCW6L1.5x1.0-..
2 x 1	3.875	98.425	1.000	25.4	TE32SCW6L2.0x1.0-..
2 x 1 1/2	3.000	76.2	1.000	25.4	TE32SCW6L2.0x1.5-..
2 1/2 x 1 1/2	3.875	98.425	1.000	25.4	TE32SCW6L2.5x1.5-..
2 1/2 x 2	3.000	76.2	1.000	25.4	TE32SCW6L2.5x2.0-..
3 x 1 1/2	4.750	120.65	1.000	25.4	TE32SCW6L3.0x1.5-..
3 x 2	3.875	98.425	1.000	25.4	TE32SCW6L3.0x2.0-..
3 x 2 1/2	3.125	79.375	1.000	25.4	TE32SCW6L3.0x2.5-..
4 x 2	5.750	146.05	1.000	25.4	TE32SCW6L4.0x2.0-..
4 x 2 1/2	4.875	123.825	1.000	25.4	TE32SCW6L4.0x2.5-..
4 x 3	4.500	114.3	1.500	38.1	TE32SCW6L4.0x3.0-..
6 x 3	8.000	203.2	1.500	38.1	TE32SCW6L6.0x3.0-..
6 x 4	6.375	161.925	1.500	38.1	TE32SCW6L6.0x4.0-..

This product is available in PM and PL surface finishes only.

* **Note:** Available upon request.

Reducers - Eccentric

TEG32SCC - SHORT ECCENTRIC REDUCER

Nominal Size in.	Dimensions		Ordering Code
	Overall Length, A, in	Overall Length, A, mm	
* 3/8 x 1/4	2.625	66.675	TEG32SCC6L.375x.25-..
* 1/2 x 1/4	2.875	73.025	TEG32SCC6L.5x.25-..
* 1/2 x 3/8	2.875	73.025	TEG32SCC6L.5x.375-..
* 3/4 x 3/8	3.000	76.2	TEG32SCC6L.75x.375-..
3/4 x 1/2	3.125	79.375	TEG32SCC6L.75x.5-..
1 x 1/2	3.500	88.9	TEG32SCC6L1.0x.5-..
1 x 3/4	3.125	79.375	TEG32SCC6L1.0x.75-..
1 1/2 x 3/4	4.000	101.6	TEG32SCC6L1.5x.75-..
1 1/2 x 1	3.500	88.9	TEG32SCC6L1.5x1.0-..
2 x 1	4.375	111.125	TEG32SCC6L2.0x1.0-..
2 x 1 1/2	3.500	88.9	TEG32SCC6L2.0x1.5-..
2 1/2 x 1 1/2	4.375	111.125	TEG32SCC6L2.5x1.5-..
2 1/2 x 2	3.500	88.9	TEG32SCC6L2.5x2.0-..
3 x 1 1/2	5.250	133.35	TEG32SCC6L3.0x1.5-..
3 x 2	4.375	111.125	TEG32SCC6L3.0x2.0-..
3 x 2 1/2	3.625	92.075	TEG32SCC6L3.0x2.5-..
4 x 2	6.250	158.75	TEG32SCC6L4.0x2.0-..
4 x 2 1/2	5.375	136.525	TEG32SCC6L4.0x2.5-..
4 x 3	5.000	127	TEG32SCC6L4.0x3.0-..
6 x 3	8.500	215.9	TEG32SCC6L6.0x3.0-..
6 x 4	7.000	177.8	TEG32SCC6L6.0x4.0-..

This product is available in PM and PL surface finishes only.

* **Note:** Available upon request.

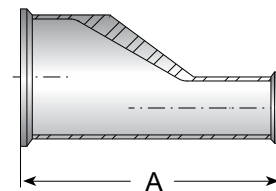

BPE TABLE # DT-4.1.3-3



Use Points

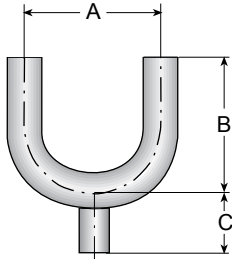

TE2UBWWW - 180° BOTTOM OUTLET WELD USE POINT

Nominal Size in.	Dimensions						Ordering Code
	A in.	A mm	B in.	B mm	C in.	C mm	
3/4 x 1/2	4.500	114.3	3.000	76.2	1.875	47.6	TE2UBWWW6L.75x.5-..
3/4 x 3/4	4.500	114.3	3.000	76.2	1.875	47.6	TE2UBWWW6L.75x.75-..
1 x 1/2	3.000	76.2	3.000	76.2	2.062	52.4	TE2UBWWW6L1.0x.5-..
1 1/2 x 1/2	4.500	114.3	4.500	114.3	2.312	58.7	TE2UBWWW6L1.5x.5-..
2 x 1/2	6.000	152.4	5.000	127.0	2.562	65.1	TE2UBWWW6L2.0x.5-..
2 1/2 x 1/2	7.500	190.5	5.750	146.1	2.812	71.4	TE2UBWWW6L2.5x.5-..
3 x 1/2	9.000	228.6	6.500	165.1	3.062	77.8	TE2UBWWW6L3.0x.5-..
4 x 1/2	12.000	304.8	8.500	215.9	3.562	90.5	TE2UBWWW6L4.0x.5-..

A & B Dimensions According to ASME BPE 2014, table DT-4.1.1-7

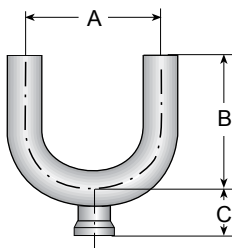

TE2UBWWC - 180° BOTTOM OUTLET CLAMP USE POINT

Nominal Size in.	Dimensions						Ordering Code
	A in.	A mm	B in.	B mm	C in.	C mm	
3/4 x 1/2	4.500	114.3	3.000	76.2	0.875	22.2	TE2UBWWC6L.75x.5-..
3/4 x 3/4	4.500	114.3	3.000	76.2	0.875	22.2	TE2UBWWC6L.75x.75-..
1 x 1/2	3.000	76.2	3.000	76.2	1.062	27	TE2UBWWC6L1.0x.5-..
1 1/2 x 1/2	4.500	114.3	4.500	114.3	1.312	33.3	TE2UBWWC6L1.5x.5-..
2 x 1/2	6.000	152.4	5.000	127	1.562	39.7	TE2UBWWC6L2.0x.5-..
2 1/2 x 1/2	7.500	190.5	5.750	146.1	1.812	46	TE2UBWWC6L2.5x.5-..
3 x 1/2	9.000	228.6	6.500	165.1	2.062	52.4	TE2UBWWC6L3.0x.5-..
4 x 1/2	12.000	304.8	8.500	215.9	2.562	65.1	TE2UBWWC6L4.0x.5-..

A & B Dimensions According to ASME BPE 2014, table DT-4.1.1-7

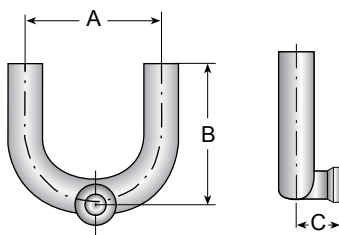

TE2USWWC - 180° SIDE OUTLET CLAMP USE POINT

Nominal Size in.	Dimensions						Ordering Code
	A in.	A mm	B in.	B mm	C in.	C mm	
3/4 x 1/2	4.500	114.3	3.000	76.2	0.875	22.2	TE2USWWC6L.75x.5-..
3/4 x 3/4	4.500	114.3	3.000	76.2	0.875	22.2	TE2USWWC6L.75x.75-..
1 x 1/2	3.000	76.2	3.000	76.2	1.062	26.9	TE2USWWC6L1.0x.5-..
1 1/2 x 1/2	4.500	114.3	4.500	114.3	1.312	33.3	TE2USWWC6L1.5x.5-..
2 x 1/2	6.000	152.4	5.000	127	1.562	39.7	TE2USWWC6L2.0x.5-..
2 1/2 x 1/2	7.500	190.5	5.750	146.1	1.812	46	TE2USWWC6L2.5x.5-..
3 x 1/2	9.000	228.6	6.500	165.1	2.062	52.4	TE2USWWC6L3.0x.5-..
4 x 1/2	12.000	304.8	8.500	215.9	2.562	65	TE2USWWC6L4.0x.5-..

A & B Dimensions According to ASME BPE 2014, table DT-4.1.1-7

True Y's & Laterals

TE28WB - TRUE Y

Nominal Size in.	Dimensions			Ordering Code
	A in.	A mm	Nom. Wall	
1	3.000	76.2	.065	TE28WB6L1.0-..
1½	3.000	76.2	.065	TE28WB6L1.5-..
2	4.000	101.6	.065	TE28WB6L2.0-..
2½	5.000	127.0	.065	TE28WB6L2.5-..
3	6.000	152.4	.065	TE28WB6L3.0-..
4	8.000	203.2	.083	TE28WB6L4.0-..
6	8.000	203.2	.109	TE28WB6L6.0-..

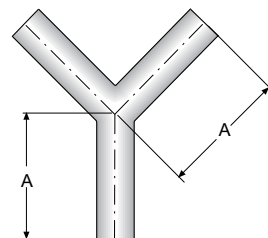

TEG28B - CLAMP TRUE Y

Nominal Size in.	Dimensions		Ordering Code
	A in.	A mm	
*1	3.500	88.9	TEG28B6L1.0-..
1½	3.500	88.9	TEG28B6L1.5-..
2	4.500	114.3	TEG28B6L2.0-..
2½	5.500	139.7	TEG28B6L2.5-..
3	6.500	165.1	TEG28B6L3.0-..
4	8.625	219.1	TEG28B6L4.0-..
6	8.875	225.4	TEG28B6L6.0-..

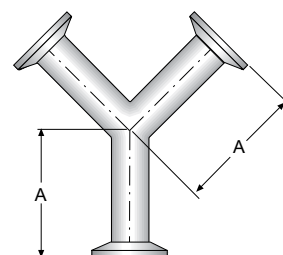

* Note: 1" Clamp Ferrule can also be orderd with "Type A" connections according to the ASME BPE standard.

True Y's & Laterals

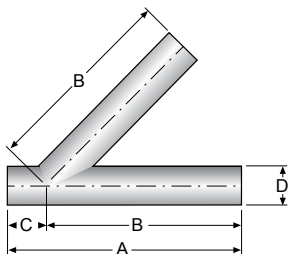

TE28WA - 45° LATERAL

Nominal Size in.	Dimensions								Ordering Code
	A in.	A mm	B in.	B mm	C in.	C mm	D in.	D mm	
*1	6.000	152.4	5.000	127.0	1.000	25.4	1.000	25.4	TE28WA6L1.0-..
1½	7.380	187.45	6.190	157.2	1.190	30.2	1.500	38.1	TE28WA6L1.5-..
2	8.750	222.3	7.120	181.0	1.630	41.4	2.000	50.8	TE28WA6L2.0-..
2½	10.000	254.0	8.500	215.9	1.500	38.1	2.500	63.50	TE28WA6L2.5-..
3	10.750	270.1	8.870	225.4	1.870	47.5	3.000	76.2	TE28WA6L3.0-..
4	12.810	325.4	10.750	273.1	2.060	52.4	4.000	101.6	TE28WA6L4.0-..
6	16.500	419.1	12.500	317.5	4.000	101.6	6.000	152.4	TE28WA6L6.0-..

* **Note:** 1" Clamp Ferrule can also be orderd with "Type A" connections according to the ASME BPE standard.

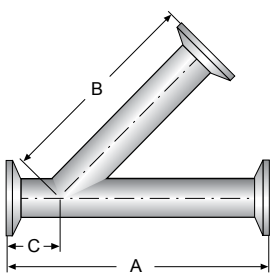

TEG28A - 45° CLAMP LATERAL

Nominal Size in.	Dimensions						Ordering Code
	A in.	A mm	B in.	B mm	C in.	C mm	
*1	7.000	177.8	5.500	139.7	1.500	38.1	TEG28A6L1.0-..
1½	8.375	212.7	6.687	169.9	1.687	42.9	TEG28A6L1.5-..
2	9.750	247.7	7.625	193.7	2.125	54.0	TEG28A6L2.0-..
2½	11.000	279.4	9.000	228.6	2.000	50.8	TEG28A6L2.5-..
3	11.750	298.5	9.375	238.1	2.375	60.3	TEG28A6L3.0-..
4	14.062	357.2	11.375	288.9	2.687	68.3	TEG28A6L4.0-..
6	18.250	479.4	15.375	390.5	4.375	111.1	TEG28A6L6.0-..

* **Note:** 1" Clamp Ferrule can also be orderd with "Type A" connections according to the ASME BPE standard.

Crosses

TE9WWWW - CROSS

Nominal Size in.	Ordering Code				
	A in.	A mm	B in.	B mm	
1/4	1.750	44.5	3.500	89.0	TE9WWWW6L.25-..
3/8	1.750	44.5	3.500	89.0	TE9WWWW6L.375-..
1/2	1.875	47.6	3.750	95.2	TE9WWWW6L.5-..
3/4	2.000	50.8	4.000	101.6	TE9WWWW6L.75-..
1	2.125	54	4.250	108.0	TE9WWWW6L1.0-..
1 1/2	2.375	60.3	4.750	120.6	TE9WWWW6L1.5-..
2	2.875	73	5.750	146.0	TE9WWWW6L2.0-..
2 1/2	3.125	79.4	6.250	158.8	TE9WWWW6L2.5-..
3	3.375	85.7	6.750	171.4	TE9WWWW6L3.0-..
4	4.125	104.8	8.250	209.6	TE9WWWW6L4.0-..
6	5.625	142.9	11.250	285.8	TE9WWWW6L6.0-..

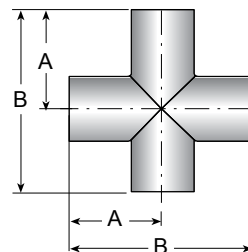

BPE TABLE# DT-4.1.2-1

TEG9 - CROSS

Nominal Size in.	Ordering Code				
	A in.	A mm	B in.	B mm	
1/4	2.250	57.2	4.500	114.3	TEG96L.25-..
3/8	2.250	57.2	4.500	114.3	TEG96L.375-..
1/2	2.250	57.2	4.500	114.3	TEG96L.5-..
3/4	2.375	60.3	4.750	120.6	TEG96L.75-..
*1	2.625	66.7	5.250	133.4	TEG96L1.0-..
1 1/2	2.875	73.0	5.750	146.0	TEG96L1.5-..
2	3.375	85.7	6.750	171.4	TEG96L2.0-..
2 1/2	3.625	92.1	7.250	184.2	TEG96L2.5-..
3	3.875	98.4	7.750	196.8	TEG96L3.0-..
4	4.750	120.7	9.500	241.4	TEG96L4.0-..
6	7.125	181.0	14.250	362.0	TEG96L6.0-..

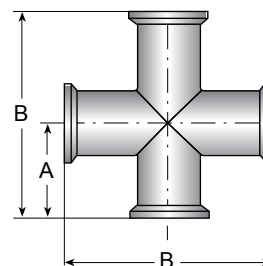

BPE TABLE# DT-4.1.2-4

* **Note:** 1" Clamp Ferrule can also be ordered with "Type A" connections according to the ASME BPE standard.

Crosses

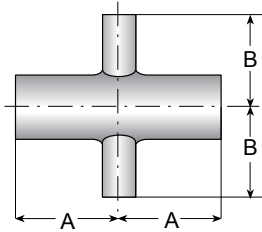

TE9RWWWW - REDUCING CROSS

Nominal Size in.	Ordering Code				
	A in.	A mm	B in.	B mm	
3/8 x 1/4	1.750	44.5	1.750	44.5	TE9RWWWWW6L.375x.25-..
1/2 x 1/4	1.875	47.6	1.875	47.6	TE9RWWWWW6L.5x.25-..
1/2 x 3/8	1.875	47.6	1.875	47.6	TE9RWWWWW6L.5x.375-..
3/4 x 1/4	2.000	50.8	2.000	50.8	TE9RWWWWW6L.75x.25-..
3/4 x 3/8	2.000	50.8	2.000	50.8	TE9RWWWWW6L.75x.375-..
3/4 x 1/2	2.000	50.8	2.000	50.8	TE9RWWWWW6L.75x.25-..
1 x 1/4	2.125	54.0	2.125	54.0	TE9RWWWWW6L1.0x.375
1 x 3/8	2.125	54.0	2.125	54.0	TE9RWWWWW6L1.0x.5
1 x 1/2	2.125	54.0	2.125	54.0	TE9RWWWWW6L1.5x.75-..
1 x 3/4	2.125	54.0	2.125	54.0	TE9RWWWWW6L1.0x.375-..
1 1/2 x 1/2	2.375	60.3	2.375	60.3	TE9RWWWWW6L1.5x.5-..
1 1/2 x 3/4	2.375	60.3	2.375	60.3	TE9RWWWWW6L1.5x.75-..
1 1/2 x 1	2.375	60.3	2.375	60.3	TE9RWWWWW6L1.5x1.0-..
2 x 1/2	2.875	73.0	2.625	66.7	TE9RWWWWW6L2.0x.5-..
2 x 3/4	2.875	73.0	2.625	66.7	TE9RWWWWW6L2.0x.75-..
2 x 1	2.875	73.0	2.625	66.7	TE9RWWWWW6L2.0x1.0-..
2 x 1 1/2	2.875	73.0	2.625	66.7	TE9RWWWWW6L2.0x1.5-..
2 1/2 x 1/2	3.125	79.4	2.875	73.0	TE9RWWWWW6L2.5x.5-..
2 1/2 x 3/4	3.125	79.4	2.875	73.0	TE9RWWWWW6L2.5x.75-..
2 1/2 x 1	3.125	79.4	2.875	73.0	TE9RWWWWW6L2.5x1.0-..
2 1/2 x 1 1/2	3.125	79.4	2.875	73.0	TE9RWWWWW6L2.5x1.5-..
2 1/2 x 2	3.125	79.4	2.875	73.0	TE9RWWWWW6L2.5x2.0-..
3 x 1/2	3.375	85.7	3.125	79.4	TE9RWWWWW6L3.0x.5-..
3 x 3/4	3.375	85.7	3.125	79.4	TE9RWWWWW6L3.0x.75-..
3 x 1	3.375	85.7	3.125	79.4	TE9RWWWWW6L3.0x1.0-..
3 x 1 1/2	3.375	85.7	3.125	79.4	TE9RWWWWW6L3.0x1.5-..
3 x 2	3.375	85.7	3.125	79.4	TE9RWWWWW6L3.0x2.0-..
3 x 2 1/2	3.375	85.7	3.125	79.4	TE9RWWWWW6L3.0x2.5-..
4 x 1/2	4.125	104.8	3.625	92.1	TE9RWWWWW6L4.0x.5-..
4 x 3/4	4.125	104.8	3.625	92.1	TE9RWWWWW6L4.0x.75-..
4 x 1	4.125	104.8	3.625	92.1	TE9RWWWWW6L4.0x1.0-..
4 x 1 1/2	4.125	104.8	3.625	92.1	TE9RWWWWW6L4.0x1.5-..
4 x 2	4.125	104.8	3.875	98.4	TE9RWWWWW6L4.0x2.0-..
4 x 2 1/2	4.125	104.8	3.875	98.4	TE9RWWWWW6L4.0x2.5-..
4 x 3	4.125	104.8	3.875	98.4	TE9RWWWWW6L4.0x3.0-..
6 x 3	5.625	142.9	4.875	123.8	TE9RWWWWW6L6.0x3.0-..
6 x 4	5.625	142.9	5.125	130.2	TE9RWWWWW6L6.0x4.0-..

Note: Additional sizes are available upon request.

Ferrules

TEG14AM7 - CLAMP FERRULE LONG

Nominal Size in.	Type	A in.	A mm	D in.	D mm	Ordering Code
1/4	A	1.750	44.5	0.984	24.9	TEG14AM7 6L.25-..
3/8	A	1.750	44.5	0.984	24.9	TEG14AM7 6L.375-..
1/2	A	1.750	44.5	0.984	24.9	TEG14AM7 6L.5-..
3/4	A	1.750	44.5	0.984	24.9	TEG14AM7 6L.75-..
1	A	1.750	44.5	1.339	34.0	TEG14AM7 6L1.0-A..
1	B	1.750	44.5	1.984	50.3	TEG14AM7 6L1.0-..
1 1/2	B	1.750	44.5	1.984	50.3	TEG14AM7 6L1.5-..
2	B	2.250	57.2	2.516	63.9	TEG14AM7 6L2.0-..
2 1/2	B	2.250	57.2	3.047	77.3	TEG14AM7 6L2.5-..
3	B	2.250	57.2	3.579	90.9	TEG14AM7 6L3.0-..
4	B	2.250	57.2	4.682	118.9	TEG14AM7 6L4.0-..
6	B	3.000	76.2	6.570	166.8	TEG14AM7 6L6.0-..

For type A&B technical information please refer to page 46

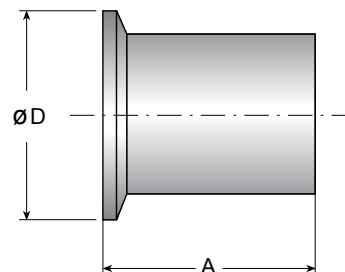

BPE TABLE # DT-4.1.4-1(A)

TEG14BM7 - CLAMP FERRULE MEDIUM

Nominal Size in.	Type	A in.	A mm	D in.	D mm	Ordering Code
1/4	A	1.130	28.7	0.984	24.9	TEG14BM7 6L.25-..
3/8	A	1.130	28.7	0.984	24.9	TEG14BM7 6L.375-..
1/2	A	1.130	28.7	0.984	24.9	TEG14BM7 6L.5-..
3/4	A	1.130	28.7	0.984	24.9	TEG14BM7 6L.75-..
1	A	1.130	28.7	1.339	34.0	TEG14BM7 6L1.0-A..
1	B	1.130	28.7	1.984	50.3	TEG14BM7 6L1.0-..
1 1/2	B	1.130	28.7	1.984	50.3	TEG14BM7 6L1.5-..
2	B	1.130	28.7	2.516	63.9	TEG14BM7 6L2.0-..
2 1/2	B	1.130	28.7	3.047	77.3	TEG14BM7 6L2.5-..
3	B	1.130	28.7	3.579	90.9	TEG14BM7 6L3.0-..
4	B	1.130	28.7	4.682	118.9	TEG14BM7 6L4.0-..
6	B	1.500	38.1	6.570	166.8	TEG14BM7 6L6.0-..

For type A&B technical information please refer to page 46

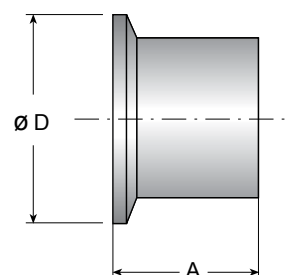

BPE TABLE # DT-4.1.4-1(B)

TEG2CS - CLAMP FERRULE SHORT

Nominal Size in.	Type	A in.	A mm	D in.	D mm	Ordering Code
1/4	A	0.500	12.7	0.984	24.9	TEG2CS 6L.25-..
3/8	A	0.500	12.7	0.984	24.9	TEG2CS 6L.375-..
1/2	A	0.500	12.7	0.984	24.9	TEG2CS 6L.5-..
3/4	A	0.500	12.7	0.984	24.9	TEG2CS 6L.75-..
1	A	0.500	12.7	1.339	34.0	TEG2CS 6L1.0-A..
1	B	0.500	12.7	1.984	50.3	TEG2CS 6L1.0-..
1 1/2	B	0.500	12.7	1.984	50.3	TEG2CS 6L1.5-..
2	B	0.500	12.7	2.516	63.9	TEG2CS 6L2.0-..
2 1/2	B	0.500	12.7	3.047	77.3	TEG2CS 6L2.5-..
3	B	0.500	12.7	3.579	90.9	TEG2CS 6L3.0-..
4	B	0.625	15.9	4.682	118.9	TEG2CS 6L4.0-..
6	B	0.750	19.1	6.570	166.8	TEG2CS 6L6.0-..

For type A&B technical information please refer to page 46

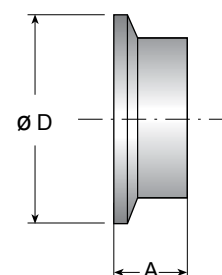

BPE TABLE # DT-4.1.4-1(C)

Solid End Caps & Weld Caps

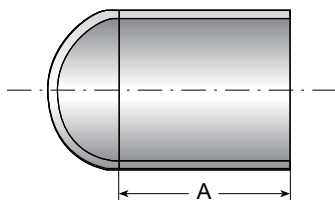

BPE TABLE # DT-4.1.5-1

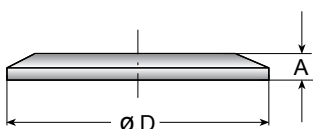

BPE TABLE # DT-4.1.5-2

TE16W - WELD CAP

Nominal Size in.	Ordering Code		
	A in.	A mm	
1/2	1.500	38.1	TE16W6L5-..
3/4	1.500	38.1	TE16W6L75-..
1	1.500	38.1	TE16W6L1.0-..
1 1/2	1.500	38.1	TE16W6L1.5-..
2	1.500	38.1	TE16W6L2.0-..
2 1/2	1.500	38.1	TE16W6L2.5-..
3	1.750	44.5	TE16W6L3.0-..
4	2.000	50.8	TE16W6L4.0-..
6	2.500	63.5	TE16W6L6.0-..

TEG16A - SOLID END CAP

Nominal Size in.	Ordering Code				
	A in.	A mm.	D in.	D mm.	
1/4	0.187	4.7	0.984	24.9	TEG16A6L.75-..
3/8	0.187	4.7	0.984	24.9	TEG16A6L.75-..
1/2	0.187	4.7	0.984	24.9	TEG16A6L.75-..
3/4	0.187	4.7	0.984	24.9	TEG16A6L.75-..
1 (Type A)	0.250	6.4	1.339	34.0	TEG16A6L1.0-A..
1	0.250	6.4	1.984	50.3	TEG16A6L1.5-..
1 1/2	0.250	6.4	1.984	50.3	TEG16A6L1.5-..
2	0.250	6.4	2.516	63.9	TEG16A6L2.0-..
2 1/2	0.250	6.4	3.047	77.3	TEG16A6L2.5-..
3	0.250	6.4	3.579	90.9	TEG16A6L3.0-..
4	0.312	7.9	4.682	118.9	TEG16A6L4.0-..
6	0.437	11.1	6.570	166.8	TEG16A6L6.0-..

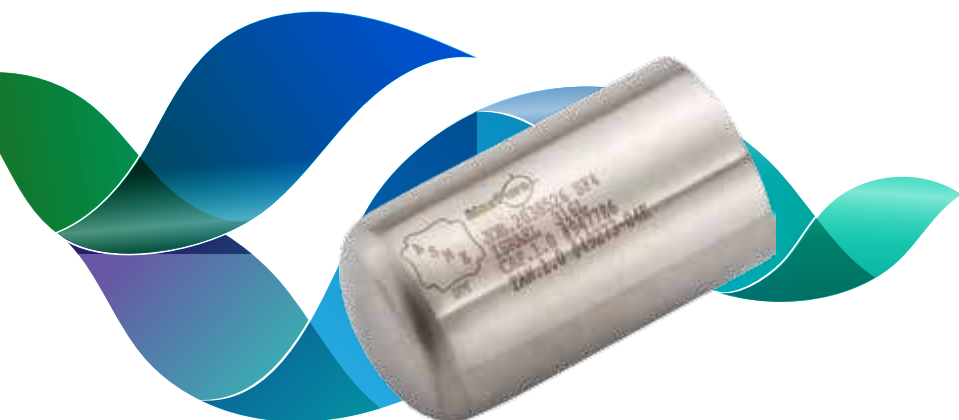

Gaskets

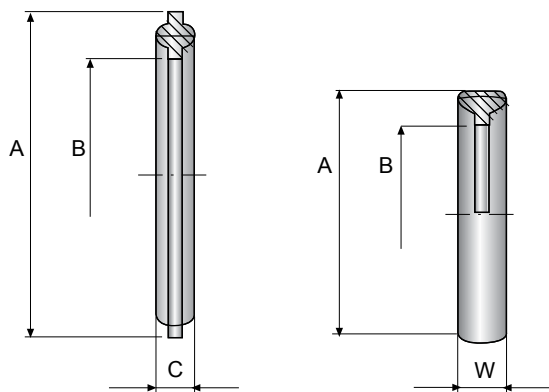

TEG40 - GASKET

Nominal Size in.									Ordering Code
	A in.	A mm	B in.	B mm	C in.	C mm	W in.	W mm	
1/2	1.000	25.40	0.370	9.40	-	-	0.22	5.50	TEG40.5*
3/4	1.000	25.40	0.618	15.70	-	-	0.22	5.50	TEG40.75*
1 Type A	1.340	34.00	0.900	22.86	0.20	5.08	-	-	TEG401.0-A*
1	1.975	50.16	0.900	22.86	0.20	5.08	-	-	TEG401.0*
1 1/2	1.975	50.16	1.400	35.56	0.20	5.08	-	-	TEG401.5*
2	2.500	63.50	1.900	48.26	0.20	5.08	-	-	TEG402.0*
2 1/2	3.000	76.20	2.400	60.96	0.20	5.08	-	-	TEG402.5*
3	3.575	90.80	2.900	73.66	0.20	5.08	-	-	TEG403.0*
4	4.690	119.12	3.875	98.42	0.20	5.08	-	-	TEG404.0*
6	6.600	167.64	5.840	148.33	0.20	5.08	-	-	TEG406.0*

* Please specify the gasket material.

Note: Gaskets are type USP Class VI Pharmaceutical Grade.

GASKET MATERIALS:

PTFE®

VITON®

Envelope type - TEFLON with EPDM Filler

TEFLON with VITON Filler

SILICON

BUNA

EPDM and TEF-STEEL®

Clamps

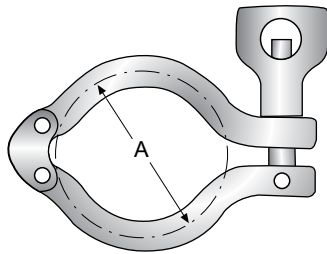

13MHHMD - DOUBLE HINGED HEAVY DUTY CLAMP

Nominal Size in.	Ordering Code		
	A in.	A mm	
1½	2.122	53.9	13MHHMD1.5
2	2.654	67.4	13MHHMD2.0
2½	3.185	80.8	13MHHMD2.5
3	3.717	94.4	13MHHMD3.0
4	4.820	108.7	13MHHMD4.0

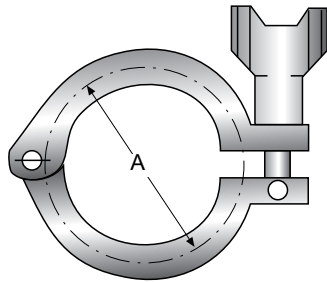

13MHHM - HEAVY DUTY CLAMP

Nominal Size in.	Ordering Code		
	A in.	A mm	
½ & ¾	1.125	28.5	13MHHM.5
1 Type A	1.472	37.4	13MHHM1.0-A
1 & 1½	2.122	53.9	13MHHM1
2	2.654	64.5	13MHHM2.0
2½	3.185	80.8	13MHHM2.5
3	3.717	94.4	13MHHM3.0
4	4.820	122.42	13MHHM4.0
6	6.695	170.05	13MHHM6.0

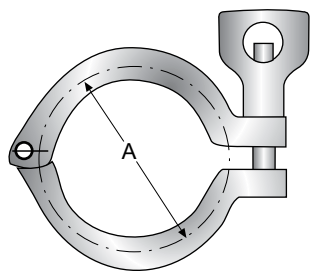

13MHHM-H HEAVY DUTY CLAMP (WING NUT WITH HOLE)

Nominal Size in.	Ordering Code		
	A in.	A mm	
½ & ¾	1.125	28.9	13MHHM.5-H
1 Type A	1.472	37.4	13MHHM1.0-H-A
1 & 1½	2.122	53.9	13MHHM1-H
2	2.654	67.4	13MHHM2.0-H
2½	3.185	80.8	13MHHM2.5-H
3	3.717	94.4	13MHHM3.0-H
4	4.820	122.4	13MHHM4.0-H
6	6.695	170.05	13MHHM6.0-H

Clamps

13MHHS - THREE PIECE HEAVY DUTY CLAMP

Nominal Size in.	Ordering Code		
	A in.	A mm	
1½	2.122	53.9	13MHHS1.5
2	2.654	67.4	13MHHS2.0
2½	3.185	80.8	13MHHS2.5
3	3.717	94.4	13MHHS3.0
4	4.820	108.7	13MHHS4.0

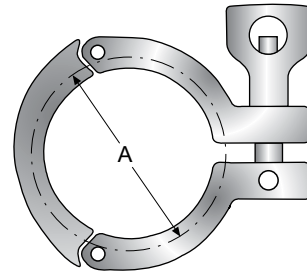

13MHP - HIGH PRESSURE CLAMP

Nominal Size in.	Ordering Code		
	A in.	A mm	
½ & ¾	1.062	26.97	13MHP5
1½	2.046	51.97	13MHP1.5
2	2.578	65.48	13MHP2.0
2½	3.110	78.99	13MHP2.5
3	3.640	92.46	13MHP3.0
4	4.744	120.50	13MHP4.0
6	6.632	168.45	13MHP6.0

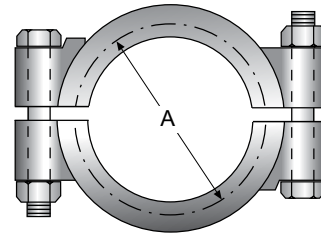

Hose Adapters

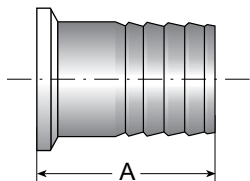

TEG14RT - HOSE ADAPTER

Nominal Size in.	Ordering Code		
	A in.	A mm	
1/2 x 1/4	1.500	38.1	TEG14RT6L.5x.25-..
1/2 x 3/8	1.500	38.1	TEG14RT6L.5x.375-..
1/2 x 1/2	1.500	38.1	TEG14RT6L.5x.5-..
3/4 x 1/4	1.500	38.1	TEG14RT6L.75x.25-..
3/4 x 3/8	1.500	38.1	TEG14RT6L.75x.375-..
3/4 x 1/2	1.500	38.1	TEG14RT6L.75x.5-..
3/4	1.500	38.1	TEG14RT6L.75-..
*1	1.690	42.9	TEG14RT6L1.0-..
1 1/2	1.690	42.9	TEG14RT6L1.5-..
2	2.310	58.7	TEG14RT6L2.0-..
2 1/2	2.300	59.5	TEG14RT6L2.5-..
3	3.090	78.6	TEG14RT6L3.0-..
4	3.410	86.5	TEG14RT6L4.0-..

* Note: 1" Clamp Ferrule can also be ordered with 'Type A' connections according to the ASME BPE 2014 standard.

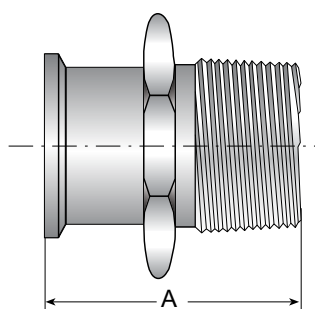

1" THROUGH 4"

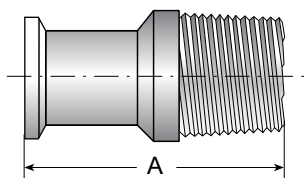

1/2" & 3/4" SIZES

TEG21 - CLAMP ADAPTER X MALE NPT

Nominal Size in.	Ordering Code		
	A in.	A mm	
1/2 x 1/8	2.000	50.8	TEG216L.5x.125-..
1/2 x 1/4	2.000	50.8	TEG216L.5x.25-..
1/2 x 3/8	2.000	50.8	TEG216L.5x.375-..
1/2 x 1/2	2.000	50.8	TEG216L.5-..
1/2 x 3/4	2.000	50.8	TEG216L.5x.75-..
3/4 x 1/8	2.000	50.8	TEG216L.75x.125-..
3/4 x 1/4	2.000	50.8	TEG216L.75x.25-..
3/4 x 3/8	2.000	50.8	TEG216L.75x.375-..
3/4 x 1/2	2.000	50.8	TEG216L.75x.5-..
3/4 x 3/4	2.000	50.8	TEG216L.75-..
*1	2.250	57.1	TEG216L1.0-..
1 1/2	2.440	61.9	TEG216L1.5-..
2	2.660	67.5	TEG216L2.0-..
2 1/2	3.280	83.3	TEG216L2.5-..
3	3.500	88.9	TEG216L3.0-..
4	3.810	96.7	TEG216L4.0-..

* Note: 1" Clamp Ferrule can also be ordered with 'Type A' connections according to the ASME BPE 2014 standard

Adapters

TEG22 - CLAMP ADAPTER X FEMALE NPT

Nominal Size in.	A		Ordering Code
	A in.	A mm	
1/2 x 1/8	2.000	50.8	TEG226L.5x.125-..
1/2 x 1/4	2.000	50.8	TEG226L.5x.25-..
1/2 x 3/8	2.000	50.8	TEG226L.5x.375-..
1/2 x 1/2	2.000	50.8	TEG226L.5-..
1/2 x 3/4	2.000	50.8	TEG226L.75x.75-..
3/4 x 1/8	2.000	50.8	TEG226L.75x.125-..
3/4 x 1/4	2.000	50.8	TEG226L.75x.25-..
3/4 x 3/8	2.000	50.8	TEG226L.75x.375-..
3/4 x 1/2	2.000	50.8	TEG226L.75x.5-..
3/4 x 3/4	2.000	50.8	TEG226L.75-..
*1	2.250	57.1	TEG226L1.0-..
1 1/2	2.440	61.9	TEG226L1.5-..
2	2.660	67.5	TEG226L2.0-..
2 1/2	3.280	83.3	TEG226L2.5-..
3	3.500	88.9	TEG226L3.0-..
4	3.810	96.7	TEG226L4.0-..

* Note: 1" Clamp Ferrule can also be ordered with 'Type A' connections according to the ASME BPE 2012 standard.

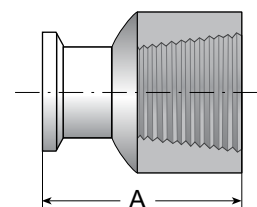

1/2" & 3/4" SIZES

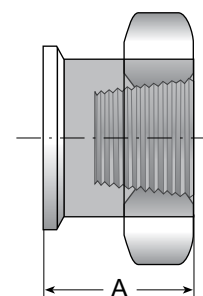

1" THROUGH 4"

Stub Ends & Slip On Flanges

TE14WA - TYPE A STUB END WITH GROOVES

Nominal Size in.	A		B		T		Ordering Code
	A in.	A mm	B in.	B mm	T in.	T mm	
1/2	2.000	50.80	1.625	41.3	0.065	1.65	TE14WA6L.5-..
3/4	2.000	50.80	1.687	42.9	0.065	1.65	TE14WA6L.75-..
1	2.000	50.80	2.000	50.8	0.065	1.65	TE14WA6L1.0-..
1 1/2	2.000	50.80	2.875	73	0.065	1.65	TE14WA6L1.5-..
2	2.500	63.50	3.265	92.1	0.065	1.65	TE14WA6L2.0-..
2 1/2	2.500	63.50	4.125	104.8	0.065	1.65	TE14WA6L2.5-..
3	2.500	63.50	5.000	127	0.065	1.65	TE14WA6L3.0-..
4	2.500	63.50	6.187	157.2	0.083	2.11	TE14WA6L4.0-..
6	3.000	76.20	8.500	215.9	0.109	2.77	TE14WA6L6.0-..

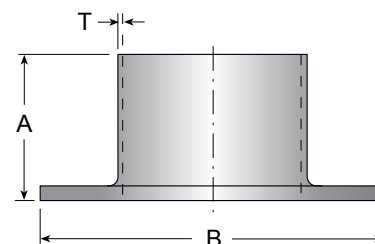



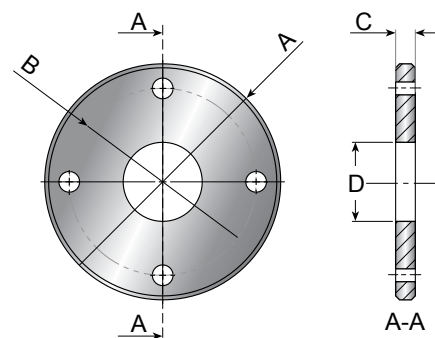

E38SL - SLIP ON FLANGE

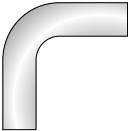

Nominal Size in.	A		B		C		D	
	A in.	A mm	B in.	B mm	C in.	C mm	D in.	D mm
1	4.250	108.0	3.125	79.4	0.375	9.5	1.010	25.7
1 1/2	5.000	127.0	3.875	98.4	0.437	11.1	1.510	38.4
2	6.000	152.4	4.750	120.7	0.500	12.7	2.010	51.1
2 1/2	7.000	177.8	5.500	139.7	0.562	14.3	2.510	63.8
3	7.500	190.5	6.000	152.4	0.625	15.9	3.010	76.5
4	9.000	228.6	7.500	190.5	0.689	17.5	4.010	101.9
6	11.000	297.4	9.500	241.3	0.811	20.6	6.010	152.9

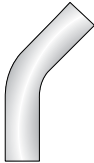

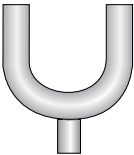
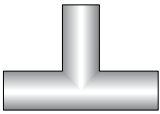
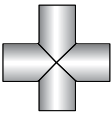
Asme Bpe Dt Index

Drawing	Part description	2009 DT According to ASME-BPE 2009	2012 DT According to ASME-BPE 2012	2014 Dt According to ASME-BPE 2014
	TE2S - 90° Elbow	DT-7	DT-4.1.1-1	DT-4.1.1-1
	TE2C - 90° Elbow clamp one end	DT-12	DT-4.1.1-2	DT-4.1.1-2
	TEG2C-90° Elbow cc	DT-16	DT-4.1.1-3	DT-4.1.1-3
	TE2KS - 45° Elbow WW	DT-8	DT-4.1.1-4	DT-4.1.1-4
	TE2KC - 45° Elbow clamp one end	DT-13	DT-4.1.1-5	DT-4.1.1-5
	TEG2K-45° Elbow CC	DT-17	DT-4.1.1-6	DT-4.1.1-6
	Elbow 180° WW (TE2UBWWW - 180° bottom outlet weld use point)	DT-23	DT-4.1.1-7	DT-4.1.1-7
	TE7WWW - Equal Tee WWW	DT-9	DT-4.1.2-1	DT-4.1.2-1
	TE9WWW - Equal Cross WWWW	DT-9	DT-4.1.2-1	DT-4.1.2-1

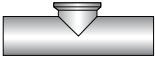
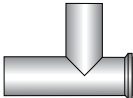
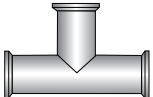
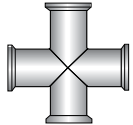
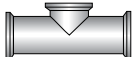
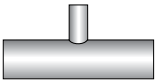
Asme Bpe Dt Index

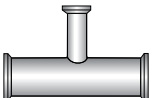
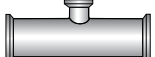
Drawing	Part description	2009 DT According to ASME-BPE 2009	2012 DT According to ASME-BPE 2012	2014 Dt According to ASME-BPE 2014
	TE7WWCS - Short outlet Tee	DT-15	DT-4.1.2-2	DT-4.1.2-2
	TE7WCSW6L - TE7WCSW - Short outlet run Tee	DT-25	DT-4.1.2-3	DT-4.1.2-3
	TEG7 - Equal Tee CCC	DT-18	DT-4.1.2-4	DT-4.1.2-4
	Straight Cross CCCC	DT-18	DT-4.1.2-4	DT-4.1.2-4
	TEG7S - Short outlet Tee	DT-27	DT-4.1.2-5	DT-4.1.2-5
	TE7RWW - Reducing TEE	DT-10	DT-4.1.2-6	DT-4.1.2-6
	TE7RWWCS - short outlet reducing Tee	DT-14	DT-4.1.2-7	DT-4.1.2-7
	TEG7R - Reducing TEE	DT-19	DT-4.1.2-8	DT-4.1.2-8
	TEG7RS - Short outlet reducing TEE	DT-20	DT-4.1.2-9	DT-4.1.2-9

Asme Bpe Dt Index

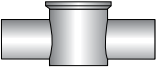
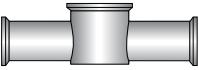
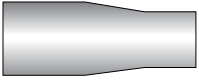
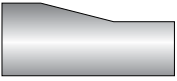
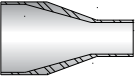
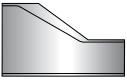
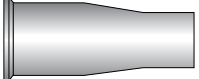
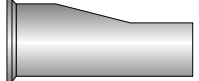
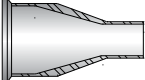
Drawing	Part description	2009 DT According to ASME-BPE 2009	2012 DT According to ASME-BPE 2012	2014 Dt According to ASME-BPE 2014
	TE7IWWCS - Instrument TEE	DT-28	DT-4.1.2-10	DT-4.1.2-10
	TEG71S - Instrument TEE	DT-29	DT-4.1.2-11	DT-4.1.2-11
	TE31WW - Long concentric reducer	DT-11	DT-4.1.3-1 (a)	N/A
	TE32WW - Long concentric reducer	DT-11	DT-4.1.3-1 (a)	N/A
	TE31SWW - Short concentric reducer	N/A	DT-4.1.3-1 (b)	DT-4.1.3-1
	TE32SWW - Short eccentric reducer	N/A	DT-4.1.3-1 (b)	DT-4.1.3-1
	TE31CW - Long concentric reducer	DT-26	DT-4.1.3-2 (a)	N/A
	TE32CW - Long concentric reducer	DT-26	DT-4.1.3-2 (a)	N/A
	TE31SCW - Short concentric reducer	N/A	DT-4.1.3-2 (b)	DT-4.1.3-2

Asme Bpe Dt Index

Drawing	Part description	2009 DT According to ASME-BPE 2009	2012 DT According to ASME-BPE 2012	2014 Dt According to ASME-BPE 2014
	TE32SCW - Short eccentric reducer	N/A	DT-4.1.3-2 (b)	DT-4.1.3-2
	TEG31CC - Long concentric reducer	DT-21	DT-4.1.3-3 (a)	N/A
	TEG32CC - Long eccentric reducer	DT-21	DT-4.1.3-3 (a)	N/A
	TEG31SCC - Short concentric reducer	N/A	DT-4.1.3-3 (b)	DT-4.1.3-3
	TEG32SCC - Short eccentric reducer	N/A	DT-4.1.3-3 (b)	DT-4.1.3-3
	Clamp ferrule long / Medium / Short	DT-22	DT-4.1.4-1	DT-4.1.4-1
	TE16W - Weld cap	DT-30	DT-4.1.5-1	DT-4.1.5-1
	TEG16A - Solid end cap	DT-31	DT-4.1.5-2	DT-4.1.5-2

Bio Fittings

BioConnect® - Clean tube connection

- Optimized recess contour (patent approved)
- Highest press-on power at the transitions to wetted areas prevents dirt and germs getting into the sealing space (see ASME-BPE, Ch. SD-3.7.2 and 3.7.6)
- Defined expansion pockets excludes dangerous "escalator effect" between wetted area and elastomer seat (see ASME-BPE, Ch. SD-3.7.2)
- Self-draining even after expansion of seal due to high temperature (see ASME-BPE, Ch. SD-3.7.7)
- Metal-to-metal-stop avoids stress or overcompression of gaskets (O-ring) (see ASME-BPE, Ch. SD-3.7.8)
- Nominal pressure PN16 (D6 - DN100, ½" - 4")

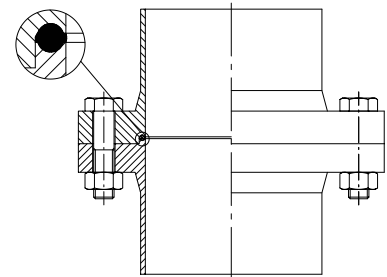

Connect S® - a unique solution without elastomer gasket

- Optimal recess contour and design of the sealing metallic surface (patent approved)
- Excellent cleanability
- Tested by Fraunhofer-Institut for Grenzflächen-und Bioverfahrenstechnik
- Hermetic tightness even under repeated temperature changes
- Defined pre-stressing on the metallic sealing surface
- No gasket - no elevator effect
- Protection of the sealing contour against damage
- Axial positioning by metal-to-metal-stop
- Exact positioning by central guidance
- Material grade 1.4435/316 L; other grades on request
- Wetted areas with roughness Ra<0,8µm (Ra<0,5µm on demand)
- Dimensions acc. ASME-BPE, DIN11866, DIN 11850,ISO 1127
- Material Test Report according EN 10204-3.1 (on request ADW 2)
- Approval for pressure application: issued by TÜV Germany (Süddeutschland)
- Nominal Pressure:
 - PN 16 (DN 6 until DN 50)
 - PN 10 (DN 65 until DN 100)
 - PN 100 (DN 6 until DN 40, high pressure-aseptic connection)

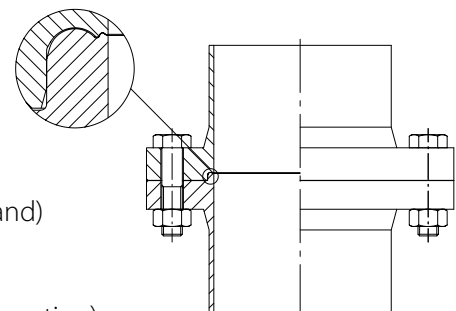

Bio Fittings

BioControl®

BioControl® is a fully aseptic modular system with TÜV-approval for pressure application. BioControl® provides the user with a fully hygienic port for connecting control instruments, gauges, sight glasses, etc..., allowing cleaning and sterilizing in place.

BioControl® system is supported by the following manufacturers of instruments and special equipment:

- Endress + Hauser
- WIKA
- LABOM
- Fisher Rosemount (EMERSON)
- Papenmeier
- Others

BioControl® allows 100% Cleaning-In-Place where typical instrument tees stay with uncleaned dead pockets.



Example: Inline - Housing

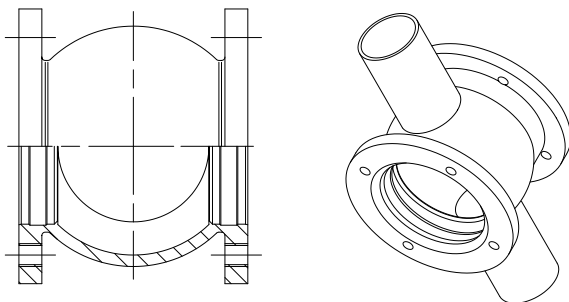

Example: Angle - Housing

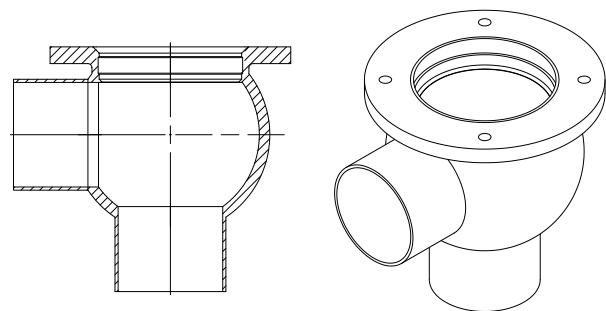

Laterals And Manifolds

EGMO offers top quality PCW, CFOS &UHP pre-fabricated laterals & manifolds for the semiconductor industry. Using EGMO unique 3D internal welding technology dead leg in laterals and manifold POC's are reduced to minimum:

- Reduce purge time.
- Reduce number of welding on-site
- Reduce cost per line

With new state of the art pre-fabrication plant and clean room facility EGMO offer the best quality laterals & manifolds.

Advantages

- Reducing field installation time by pipe contractor
- All MP & EP manifold are passivated
- Custom designed, manufactured, and 100% tested from a single source
- Reduced assembly & installation costs
- Warranted as a single part number
- Advanced and Unique internal welding technology
- Reduced dead leg in branch
- Minimum weld per manifold

Egmo laterals application

- PCW & WFI water loops
- Bulk Gases distribution systems
- Specialty gases distribution systems
- Mini Lateral for hook up

PCW Laterals

304L SCH10
Diameters: 3" - 8"
Material: 304L
Standard: ASTM A312

CFOS Laterals

316L
Diameters: 1" - 4"
Material: 316L
Standard: ASTM A269/ 270

UHP - Ultra High Purity

316L EP
Diameters: 1" - 6"
Parker Valves
For UHP gases

Manifold outlets

Weld connection
Gland connection
Clamp ferrule
Ball valve
Diaphragm valve
Compression fittings

Applications

Ultra high purity gases
Utility gas line laterals
Process Cooling Water
Short manifolds for gas cabinets

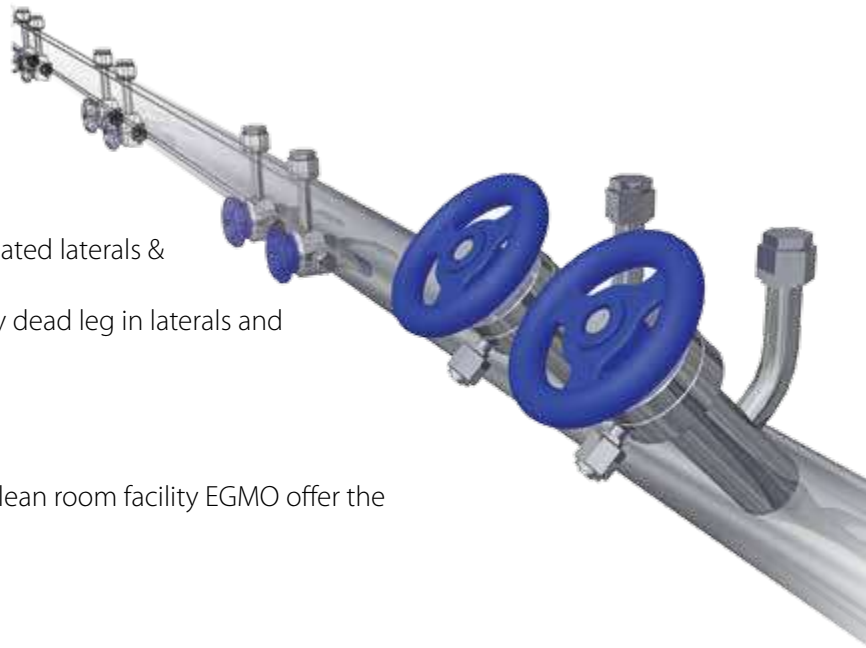

Customized Components

EGMO, VNE, and NEUMO are distinguished by their unique ability to provide the highest quality stainless steel products - ranging from special fittings, connectors, electro polished vessels and tanks with the most advanced technology, and other special accessories - for a cross-industry clientele.

Our abilities have developed and progressed over the years, allowing us to offer a one-of-a-kind business opportunity: custom stainless steel products and systems, manufactured according to client specifications and needs.

Our Vessels & custom products can be designed to meet any requirement, including vessels, abnormal sizes, special angles, sprinklers, subsystems and many more - all in compliance with industrial regulations.



Mtr - Material Test Report

The MTR is the reference document for the entire history of the production processes and the raw materials used to make the MaxPure component.

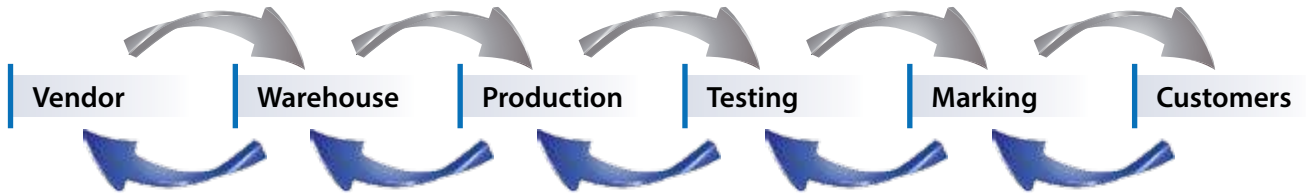

The MTR document is easily generated on-line via MaxPure.net using only the job number as input. The job number is the product identification number which represents all processes and raw materials related to the specific item.

On-Line MTR

Please, enter job/certificate number:

[CREATE CERTIFICATE >](#)



The MTR is also available for download with QR CODE

The MTR format provides the following information:

- Part number, part description and job number
- Material type
- Heat Number per each component describing the fitting and its associated properties:
 - Tube dimensions and standards
 - Chemical composition
 - Mechanical properties
 - Visual, dimensional, corrosion, EDDY current testing, flaring and flattening, PMI Test
- Certificate of Compliance

Technical Information

Pressure service ratings for sanitary stainless steel clamps

Size Tube OD	13MHHM(-H)				13MHHS				13MHP			
	@70°F / 21°C		@250°F / 121°C		@70°F / 21°C		@250°F / 121°C		@70°F / 21°C		@250°F / 121°C	
	PSI	bar	PSI	bar	PSI	bar	PSI	bar	PSI	bar	PSI	bar
½ & ¾"	1500	103	1200	83					1500	103	1200	83
1 & 1½"	500	34	250	17	600	41	300	21	1500	103	1200	83
2"	450	31	250	17	550	38	275	19	1000	69	800	55
2½"	400	28	200	14	450	31	225	16	1000	69	800	55
3"	350	24	150	10	350	24	160	11	1000	69	800	55
4"	200	14	125	9	250	17	150	10	1000	69	800	55
5"	175	12	100	7								
6"	150	10	75	5								
8"	100	7	50	3								
10"	40	3	30	2								
12"	30	2	25	2								

Note: The pressure information doesn't refer to the gaskets.

Gasket Material Properties

Property	PTFE®	VITON®	SILICON	EPDM
Temperature Range	-40 to 450° F -40 to 232° C	-20 to 400° F -29 to 204° C	-80 to 450° F -62 to 232° C	-55 to 275° F -48 to 135° C
Acid Resistance	Excellent	Good	Good	Good - excellent
Alkali Resistance	Excellent	Poor - good	Poor - fair	Good - excellent
Abrasion Resistance	Excellent	Good	Good - excellent	Good - excellent
Compression Set	Cold flows	Good - excellent	Good - excellent	Fair

Conversion Table Of Surface Finishes

Mechanical Finish		
μ-in.	μm	Grit
32 Ra	0.8 Ra	150
24 Ra	0.6 Ra	180
20 Ra	0.5 Ra	240
12 Ra	0.3 Ra	320

Technical Information

ASME BPE Table DT-7-1 Hygienic Clamp Ferrule Standard Dimensions and Tolerances

Type A

(According to the ASME BPE 2014 standard)

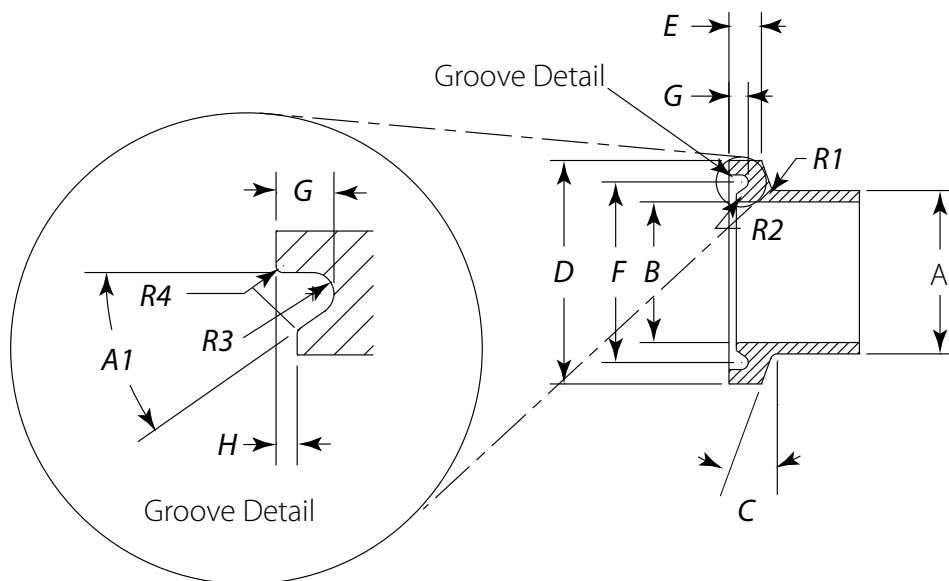

Type B

(According to the ASME BPE 2014 standard)

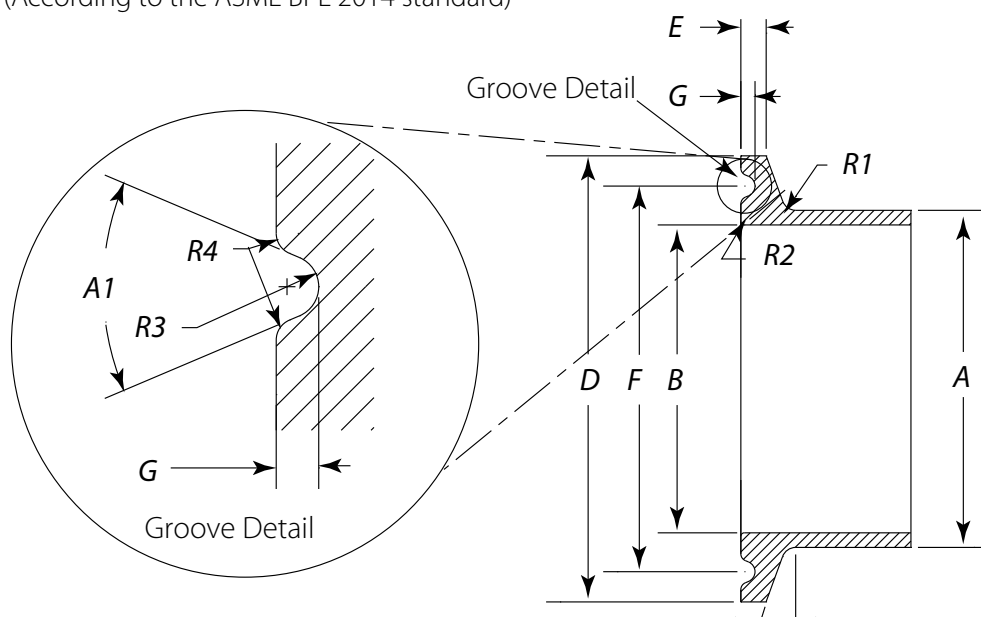

Industry Terms Glossary

Term	Acronym	Definition
A		
Alloy	-	A material composed of two or more metals which are mixed and united - usually when they are in a molten state. Alloys are created to improve properties such as the appearance, strength and durability of metals. Common alloys include cast iron, stainless steel, brass, bronze, sterling silver and alpha cellulose, that part of a material made of cellulose that is insoluble in a 17.5% solution of sodium hydroxide at 20°C under specified conditions. While alpha cellulose consists principally of cellulose, it does include other components that are insoluble under the test conditions.
American Society of Mechanical Engineers	ASME	Creates consensus standards for Mechanical Engineering.
American Society for the Testing & Materials	ASTM	Creates consensus standards for material quality and material quality testing methods
Aseptic	-	Free of pathogenic (disease causing) micro-organisms.
ASTM-A 269	ASTM-A 269	Specification titled "Seamless and Welded Austenitic Stainless Steel Tubing for General Service". This specification covers a variety of grades of austenitic stainless steel tubing.
ASTM-A 270	ASTM-A 270	Specification titled "Welded Austenitic Stainless Steel Tubing" for use in the pharmaceutical industries and need to withstand secondary cold forming operations. This specification covers a variety of grades of austenitic stainless steel tubing.
B		
Bio Processing Equipment	BPE	ASME Standard is intended for the design, materials, construction, inspection and testing of vessels, piping and related process components used in the biopharmaceutical industry and other aseptic applications.
Bio Processing Equipment Committee	BPEC	A sub-committee of the ASME BPE Main committee working to develop the ASME BPE standard while meeting three times per year.
B31.3 ASME Process Piping	B31.3	American National Standard that covers piping typically found in pharmaceutical, semiconductor, and cryogenic plants, and related processing plants and terminals. It must be noted that B31.3 does not address hygienic tubing and/or piping; it applies mostly to inspection, examination, and testing of systems.
C		
Chemical reaction	-	The process by which chemicals combine with each other to form products, which differ from, or alter, the original substances.
Clean in Place	CIP	The technique of cleaning process line components without the need for disassembly.
Conductivity	-	Measurement of a substance's ability to conduct an electric current.
Current Good Manufacturing Practice	cGMP	Written and enforced by the FDA. Consists of some specific, but mostly "umbrella" regulations covering personnel, records, and equipment, leaving much to the interpretation of the Inspector and the court system. cGMP's are evolutionary, reflecting the least common denominator of practices in the industry at present (hence the term "current").
D		
Dead Leg	-	A section of pipe in a closed recirculation loop that does not have a continuous flow through it.
Deutsches Institut für Normung (German Institute for Standardization)	DIN	Creates engineering standards for Germany Contributing body to CEN and ISO. Other countries and companies give adopted DIN standards.
E		
Electron Spectroscopy for Chemical Analysis	ESCA	A procedure that uses electron beams to characterize the extreme outer surface of a metal. Typically used to determine levels of chromium oxide on the surface of austenitic stainless steel.

Industry Terms Glossary

Term	Acronym	Definition
Electro-Polish	EP or E/P	Polishing process for metal components where the part is placed in an acid bath (typically sulfuric or phosphoric) containing a cathode. As current is passed through the cathode, metal ions are removed from the surface of the metal.
Epidemiology	-	Study of the distribution and determinants of diseases in populations.
European Hygienic Equipment Design Group	EHEDG	Comprised of representatives from research institutes, equipment manufacturers, the food and bio-pharm industry and legislative bodies . The group's objective is to provide standardization organizations (CEN and ISO) with specialist views on hygienic and aseptic design by publishing requirements and test methods.
F Fermentation	-	The biochemical synthesis of organic compounds by microorganisms or cultivated cells.
Food and Drug Administration (USA)	FDA	Enforcement agency of the U.S. government for food, drug and cosmetics manufacturing. Author of the U.S. cGMP's. Responsible for new product approvals, plant inspections and product recalls.
G Gas Tungsten Arc Welding	GTAW	(a.k.a. TIG) A welding process where the welding arc is maintained between a non-consumable tungsten electrode and the base metal to be welded. The arc is shielded with an inert gas, typically argon.
Good Manufacturing Practices	GMP	Refers specifically to FDA cGMP's (see cGMP) or to the standards of manufacturing in a particular country and industry (e.g.:EU GMP). Generally refers to standards that are written and enforced.
H Heat Tracing	-	Creates consensus standards for engineering and quality systems.
I International Standards Organization	ISO	Creates consensus standards for engineering and quality systems.
International Society for Pharmaceutical Engineering	ISPE	A global not-for-profit membership organization that provides education, training and technical publications to pharmaceutical manufacturing professionals.
M Mill Test Report or Material Test Report	MTR	(a.k.a. "Mill Certs") A document certifying the composition of a metal from a particular heat batch.
O Orbital Welding	-	An automated TIG (or GTAW) welding process that is designed to produce repeatable fusion welds for tubular components. A system consists of a programmable power supply and weld head. The power supply controls the weld parameters of current and electrode speed. The weld head holds the two parts, purges the weld and moves the electrode using an electric motor.
Ovality	-	A quantitative measurement of how 'round' a tube is by comparing width to height. Limits are specified on the appropriate ASTM specification of a product.
P Parenteral Drug Association	PDA	Association for manufacturers of injectable drug products. Publishes technical reports and other publications of interest to the industry.

Industry Terms Glossary

Term	Acronym	Definition
Passivation	-	The process of rinsing stainless steel with acid (typically nitric) to form a corrosion resistant chromium-oxide layer on the surface.
Pharma-coepidemiology	-	The study of the utilization and effects of drugs in large numbers of people. To accomplish this study, pharmacoepidemiology borrows from both pharmacology and epidemiology.
Point of Use	POU	A valved branch in a recirculating utility system (typically a water system).
Process Qualification/ Process Validation	PQ/PV	The demonstration and documentation that the various units and procedures of a process operate as they should. This logically establishes that the product is of the quality the system is purported to yield. Performed after the IQ/OQ has been executed and approved. Typically, the acceptance criteria is the same as the product acceptance criteria, and the product run is considered product-for-sale. Executed by the manufacturing personnel of the operating company according to the SOP.
R Roughness Average (Ra)	Ra	An expression of measured surface roughness or texture, typically, of a polished or machined metal surface. The arithmetic average value of the departure (peaks and valleys) of a surface profile from the center-line throughout the sampling length, generally expressed in micro-inch(µin) or micro-meter(µm) units and measured with profilometers and/or orescopes.
S Seamless Pipe	-	Pipe produced from a solid billet that is heated and rotated under pressure. This rotating pressure creates a hole in the middle of the billet, which is then formed into a pipe by a mandrel.
Solvent Cleaning	-	The removal of contaminants such as oil, grease, dirt, salts, etc. by cleaning with a solvent, steam, vapor, alkali, or emulsion.
Standard Operating Procedure	SOP	(a.k.a. EOP, OP) A controlled document that outlines the procedure for operating equipment/ systems. An operator's adherence to a written SOP is an integral part of the validation process. It is the connecting link between the initial validation process and the daily manufacturing operation.
Steam in Place	SIP	Sanitization of process line components by the use of steam without the need for disassembly.
Sterile	-	Free of living organisms.
Sulfur	-	A non-metallic element that exists in several forms-the ordinary one being a yellow, rhombic, crystalline solid-and which burns with a blue flame and a suffocating smell. Some sulfur compounds, particularly sulphides and oxides, can cause severe chemical deterioration in objects.
Surface Finish	SF	Surface finishes are all interior surface finishes accessible and inaccessible, that directly or indirectly come in contact with the designated product in bioprocessing equipment and distribution system components. Surface roughness specification and measurement standard shall be determined by Ra values rather than by polishing methods.
T Tubing Dimensions	-	O.D. - outside diameter I.D. - inside diameter Wall thickness or gauge. All tube dimensions are specific; pipe dimensions are nominal. Specific - actual measurements in inches. Nominal - theoretical or stated value of a dimension.
Tungsten Inert Gas	TIG	(a.k.a. GTAW) A welding process where the welding arc is maintained between a non-consumable tungsten electrode and the base metal to be welded. The arc is shielded with an inert gas, typically argon.

Industry Terms Glossary

Term	Acronym	Definition
U Ultra Filter or Ultra-Filtration	UF	Filters formed from polymer membranes. UFs have the ability to retain larger molecules while permitting the passage of smaller ones. Often used for the separation of proteins.
Ultraviolet Light or Ultraviolet Radiation	UV	Radiation in the ultraviolet portion of the spectrum (200 to 400 nm) is used to destroy micro-organisms. Also used to neutralize ozone.
US Pharmaceutical Class VI-XXII	USP	An official public standards-setting authority for healthcare products manufactured and sold in the United States. USP sets standards for the quality of these products which are also recognized and used outside the United States.
W Water For Injection	WFI	Water for use as a solvent for the preparation of parenteral products conforming to USPXXIII (EP and JP) guidelines. Obtained most commonly by distillation. However, other processes are allowed depending on particular pharmacopoeia.
Welded Tubing	-	Tubular products, which are rolled, formed and then joined continuously along a longitudinal seam by a material fusion process. The process employed at Gibson Tube is, Gas Tungsten Arc Welding (GTAW). See Gas Tungsten Arc Welding.



ASME BPE - Certificate



BPE

CERTIFICATE OF AUTHORIZATION

The named company is authorized by the American Society of Mechanical Engineers (ASME) for the scope shown below in accordance with the applicable rules of the ASME BPE Standard on Bioprocessing Equipment. The use of the certification mark and the authority granted by this Certificate of Authorization are subject to the provisions of the agreement set forth in the application. Any component certified under this authorization shall have been produced, assembled, and tested in accordance with the provisions of the aforementioned ASME standard.

COMPANY:

**EGMO Ltd.
MaxPure
1 Hayotsrim St.
Nahariya 2210
Israel**

SCOPE:

Manufacturer of ferrous fittings and supplier of ferrous tubing at the above location only

AUTHORIZED: **May 21, 2013**

EXPIRES: **May 21, 2018**

CERTIFICATE NUMBER: **BPE-102**

The American Society of Mechanical Engineers



Vice President, Conformity Assessment



Director, Conformity Assessment



NEUMO EHRENBERG GROUP

GLOBAL LOCATIONS



NEUMO GmbH+Co. KG (D)
 Tel: +49 (0) 7043 36 0
 Fax: +49 (0) 7043 36 179
 E-Mail: info@neumo.de
 www.neumo.de
GERMANY



VNE Corporation
 Tel: +1 800 356 1111
 +1 608 756 4930
 Fax: +1 608 756 3643
 E-Mail: stainless@vnecorp.com
 www.vnestainless.com
U.S.A



EGMO Ltd.
 Tel: +972 (0) 4 9855 176
 +972 (0) 4 9855 111
 Fax: +972 (0) 4 9855 175
 E-Mail: salese@egmo.co.il
 www.egmo.co.il
ISRAEL



NEUMO-EGMO Spain S.L
 Tel: +34 977 524 914
 Fax: +34 977 524 898
 E-Mail: neumo-es@neumo-es.com
 www.neumo-es.com
SPAIN



HPT Inc.
 Tel: +845.452.1103
 +800.284.4478
 E-Mail: sales@hptinc.com
 http://www.hptinc.com/
U.S.A



Herrli AG
 Tel: +41 (0) 31 750 12 11
 Fax: +41 (0) 31 750 12 00
 E-Mail: info@herrli.net
 www.herrli.net
SWITZERLAND



NEUMO Polska Sp. z.o.o
 Tel: +48 (0) 46 833 4306
 Fax: +48 (0) 46 832 5626
 E-Mail: neumo@neumo.pl
POLAND



NEUMO Turkey
 Tel: +90 (212) 875 01 41
 Fax: +90 (212) 875 23 13
 E-Mail: info@neumo.com.tr
 www.neumo.com.tr
TURKEY



NEUMO Budapest Kft
 Tel: +36 (1) 3174177
 +36 (1) 3185982
 Fax: +36 (1) 266 8765
 E-Mail: neumo@neumo.hu
 www.neumo.hu
HUNGARY



NEUMO GmbH + Co. KG
 Tel: +84 (4) 3773 6586
 Fax: +84 (4) 3773 6587
 E-Mail: info@neumo.com.vn
 www.neumo.co.vn
VIETNAM



NEUMO-VARGUS (Shanghai)
 Trading Co., Ltd
 Tel: +86 (21) 54178180
 Fax: +86 (21) 54178190
 E-Mail: info@neumo.com.cn
CHINA



NEUMO UK Ltd.
 Tel: +44 (0) 1952 583 999
 Fax: +44 (0) 1952 583 958
 E-Mail: stainless@neumo.co.uk
 www.neumo.co.uk
UNITED KINGDOM



AWH Armaturenwerke (D)
 Hötensleben GmbH
 Tel: +49 (0) 39405 92 0
 Fax: +49 (0) 39405 92 111
 E-Mail: info@awh.de
 www.awh.de



NEUMO
 Tel: +353 (0)21 4975540
 Cel: +353 (0)87 2330469
 E-Mail: dosullivan@neumo.de
 www.neumo.de/en/
IRELAND



Damstahl a/s (Denmark)
 Tel: +45 (0) 8794 4000
 Fax: +45 (0) 8794 4150
 E-Mail: ds@damstahl.com
 www.damstahl.dk
DENMARK

Damstahl GmbH (D)
 Tel: +49 (0) 2173 797 0
 Fax: +49 (0) 2173 797 274
 E-Mail: ds@damstahl.de
 www.damstahl.de



Damstahl a/s Oslo (N)
 Tel: +47 5615 1570
 Fax: +47 5615 1571
 E-Mail: dano@damstahl.com
 www.damstahl.no
NORWAY



Damstahl a/b (Sweden)
 Tel: +46 87 61 71 00
 Fax: +46 87 61 14 05
 www.damstahl.se
SWEDEN

Gebr. Rieger GmbH+Co. KG (D)
 Tel: +49 (0) 7361 5702 0
 Fax: +49 (0) 7361 5702 51
 E-Mail: info@rr-rieger.de
 www.rr-rieger.de
GERMANY



Semiconductor



Bio-Pharm



Hygienic